

Technical characteristics

- Power supply: 230 V~ 0.6 VA
- 2 powered contact outputs: TYXIA 5630 (1 A) - TYXIA 5730 (2 A)
- Stand-by consumption: 0.06 W
- Number of associated transmitters: 16 maximum
- Storage temperature: -10°C/+70°C
- Operating temperature: -10°C/+40°C
- IP 40 (flush mounting box)
- Dimensions: 41 x 36 x 14.5 mm
- X3D wireless remote control device: 868.7 MHz to 869.2 MHz
- Maximum radio power < 10 mW
- Receiver category: 2



Support

The receiver locks in off mode

When an overload is detected, the product locks in off mode for 30 seconds before authorising a new activation. The LED flashes rapidly throughout this phase.

For TYXIA 5630 receivers:
- Replace your receiver with a TYXIA 5730.

For TYXIA 5730 receivers:
- Contact our customer service.



An additional user guide is available on the TYXIA 5630 and TYXIA 5730 pages of the DELTA DORE website.
www.deltadore.com

TYXIA 5630 - TYXIA 5730

EN Receiver for roller shutter



EN Recommendations

- **IMPORTANT:** the control wires are not insulated from the mains power supply. All connected equipment must be marked CE and meet the requirements of the low voltage devices as well as assembly recommendations. Local control wires can be extended up to 10 m (separate from the 230 V).
- The roller shutter high and low stops must be set before the receiver is installed.

Use an electrically isolated tool to perform the actions on the receiver configuration button.

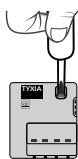

20A max. 20A circuit breaker max. required.

I - Installation

230V~ **Switch off the installation power supply OFF**

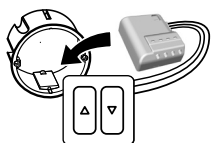

You can install the receiver for roller shutter in a flush-mounted box behind a switch or control push-button or in a sealed box inside the roller shutter, a safe distance from metal parts.

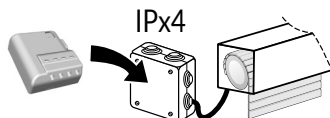

1.1 Connection instructions for terminals 1 2 3 4.

- Strip the wires while respecting the strip length specified on the product.
- Push the wire fully into the terminal.

Ø 0,75 - 1,5 mm²

1.1.1 Solid wires

1.1.2 Stranded wires

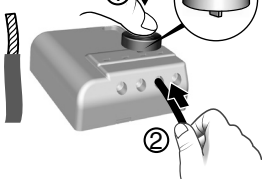
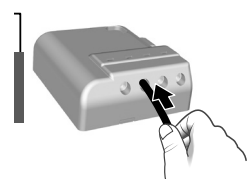

Using the tool supplied or a 2.5 mm screwdriver, press the terminal button then insert the wire.

Removal recommendations

- Switch off the power supply.
- Use the tool supplied or a 2.5 mm screwdriver to press the button of the front terminal before removing the wire.

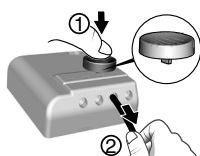

1.2 Connection instructions for IN1 - COM - IN2 terminals

- Use the wires supplied.
- Push the wire fully into the terminal.

Do not strip the wires when they are connected to the product as you could damage the internal connector.

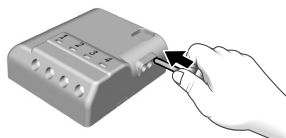

7mm 0,5 mm² KY31A02

Removal recommendations
Turn the wire while pulling on it.

1.3 Connection

- Connect the motor control wires to terminals 3 and 4 (motor lowering control wire to terminal 3, raising control wire to terminal 4).
- Connect the switch to the IN1 - COM - IN2 terminals.
- Connect the 230 V power supply to terminals 1 and 2.
- Switch the installation power back on to continue with the association operation.

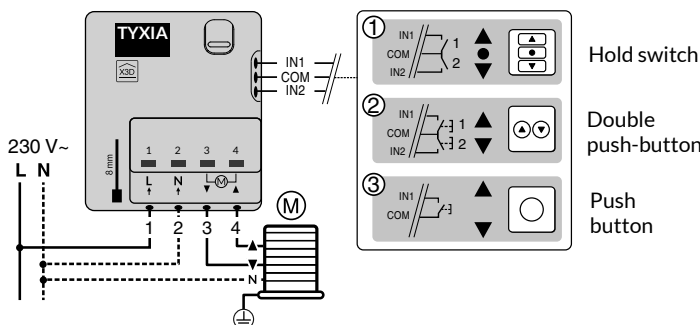

2 - Association

- 1 - Press and hold the receiver button for 3 seconds until the LED flashes, release.
- 2 On the transmitter:
- Send the association command (Refer to the user guide).

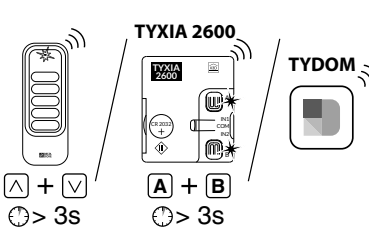
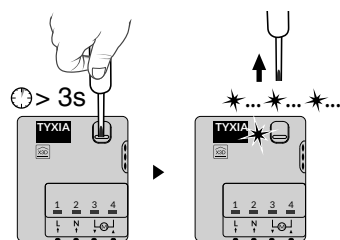

- 3 When the receiver LED has stopped flashing. The products are associated.

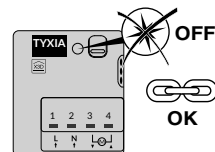

3 - Configuration

Configure the receiver according to the type of switch connected.

Mode 1 (by default): Hold switch Raise/Stop/Lower

Mode 2: Raise/Lower double push-button Raise + Lower: Stop

Mode 3: Raise/Stop/Lower/Stop push-button

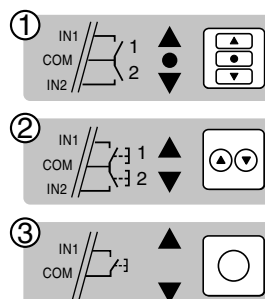

To modify the receiver configuration.

- Press the receiver's button for 6 seconds.
- The LED flashes, then becomes steady, release. The number of flashes corresponds to the current mode.

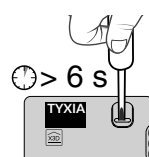

- Briefly press the receiver button to select the mode.

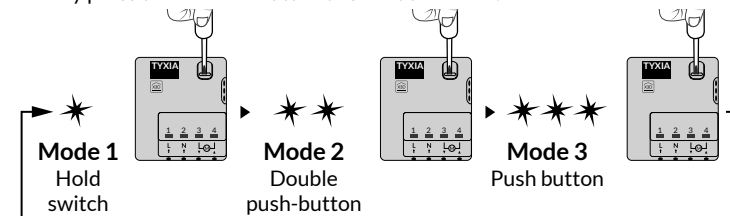

- Confirm the selected mode by pressing the button for 3 seconds until the LED switches off.

4 - Learning for the shutter travel time

Perform a complete cycle from stop to stop:

- 1- Lower or raise the roller shutter completely to the stop.
- 2- Do the reverse action until the opposite stop is reached.

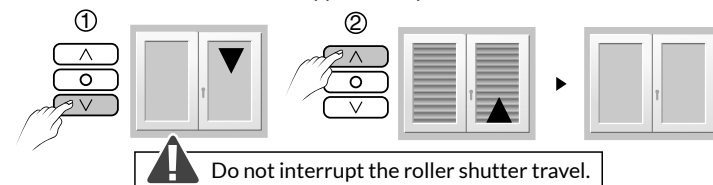

Note: The learning for the shutter travel time adjusts itself automatically for each complete cycle from stop to stop. If the motor has 4 wires (Live/Neutral/Raise/Lower) or if the power of the connected motor is less than 45 W, or if an electronic motor is fitted (e.g. Hard-wired Tymoov), Tyxia 5630/5730 cannot perform automatic learning for the shutter travel time. The receiver or receivers must be configured in "manual learning mode" (see additional instructions on the Tyxia 5630-5730 pages on the DELTADORE site).

5 - Troubleshooting

Summary of functions accessible using the receiver button:

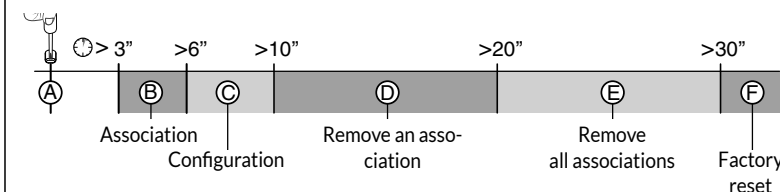

Quick press on the button.

(A) Checking the transmitter operating mode. Briefly press the button.

- The LED flashes:
- 1 red flash: MODE 1 Hold switch (Raise/Stop/Lower).
- 2 red flashes: MODE 2 Double push-button (Raise/Lower).
- 3 red flashes: MODE 3 Single push-button (Raise/Stop/Lower/Stop).

Press and hold the button for x seconds.

- (B) Association (refer to §2)**
- Press the receiver button for 3 seconds until the LED flashes. Release
- (C) Configuration (refer to §3)**
- Press the receiver's button for 6 seconds. The LED flashes, then becomes steady, release.
- (D) Remove an association**
(the removal method varies according to the transmitter associated, refer to the transmitter's user guide)

- Example of removing a remote control association.
On the receiver:
- Press the receiver button for 10 seconds until the LED flashes rapidly, release.
On the remote control:
- Press the ^ and v buttons for 3 seconds.
- Make sure that the receiver LED has stopped flashing. The products are no longer associated.
- (E) Remove all associations**
- Press the receiver's button for 20 seconds.
- Press and hold until the LED switches off after the rapid flashing phase.
- Release. The receiver has no wireless connection.
- (F) Factory reset**
- Press the receiver button for 30 seconds, the LED flashes then switches off. The receiver has no wireless connection and the configuration is reset (mode 1 by default).