

# Little Anne

## User Guide

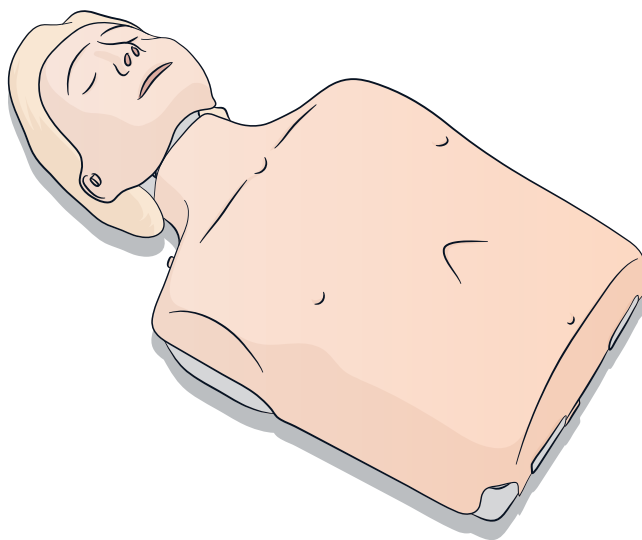

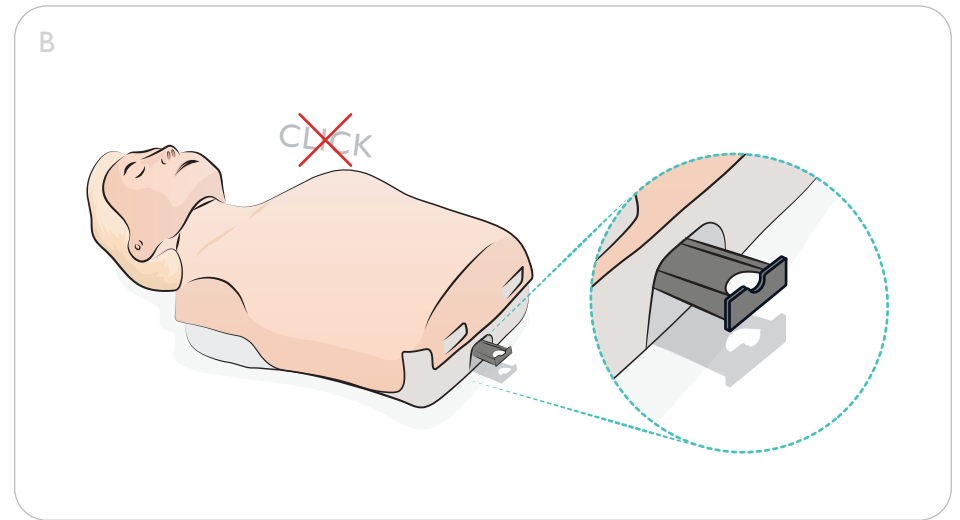

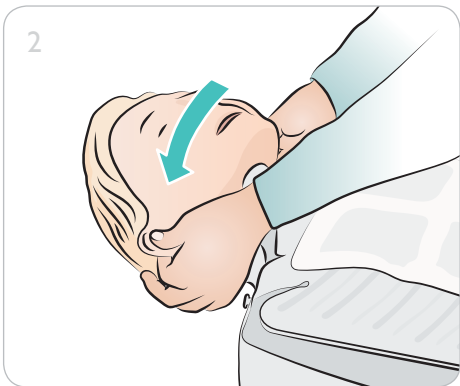
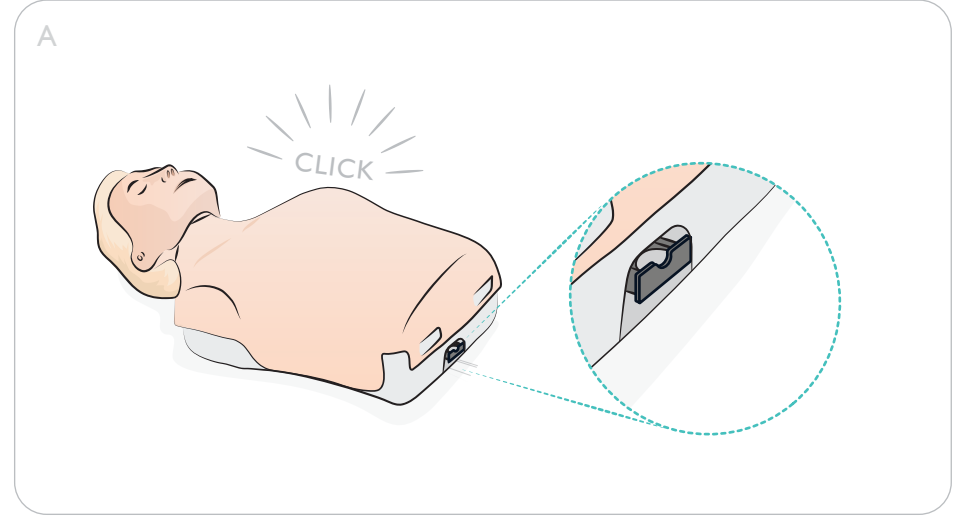
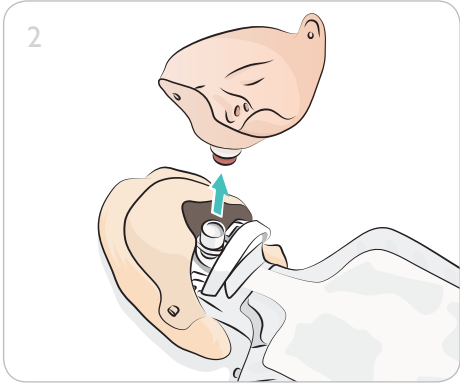
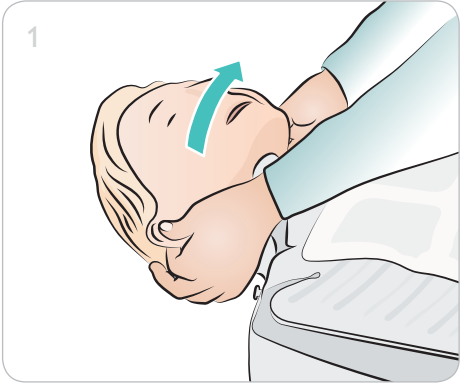
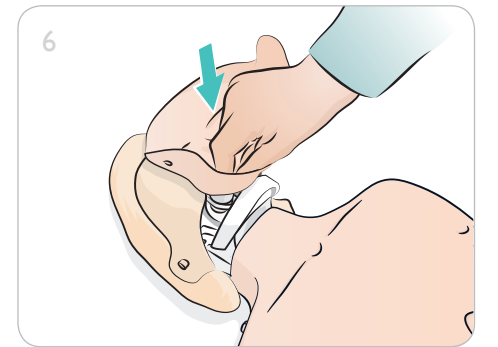
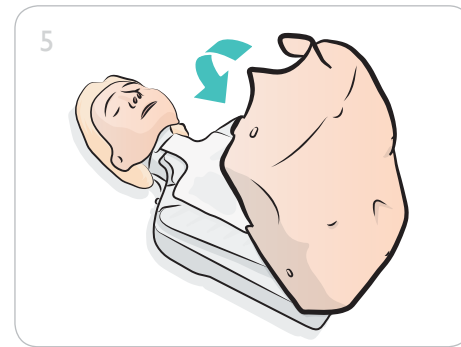
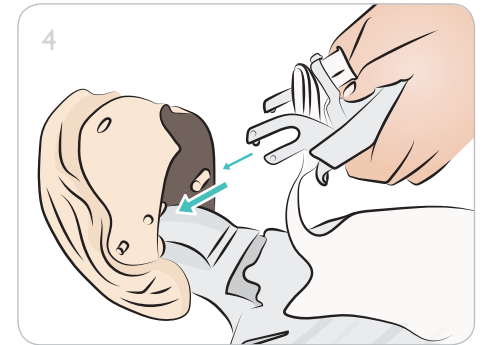
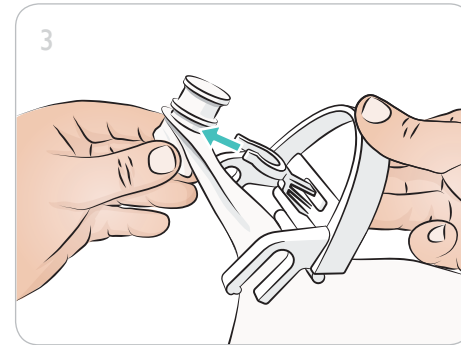
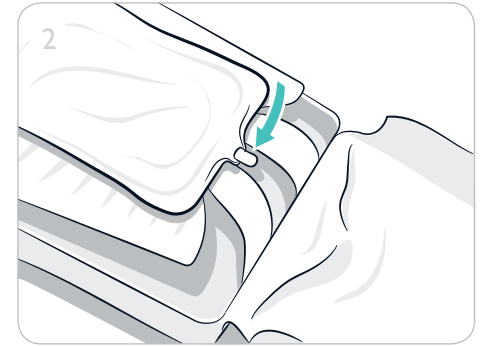
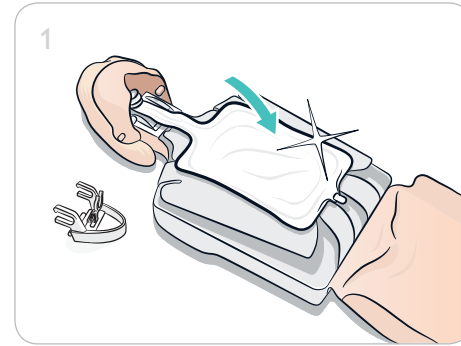
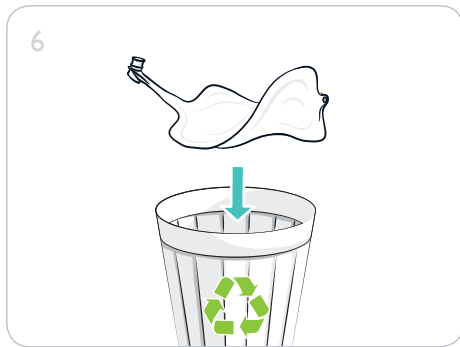
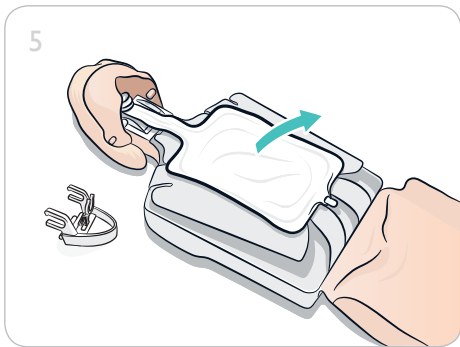
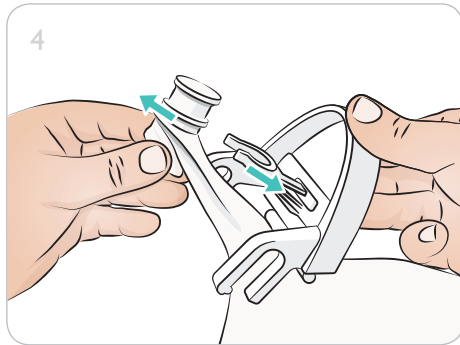
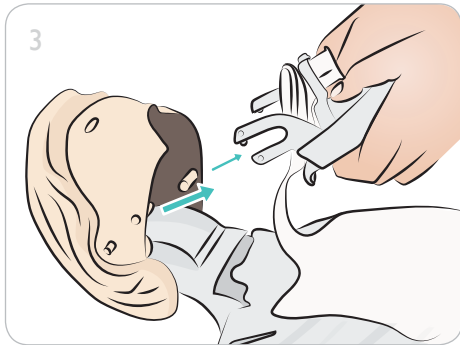
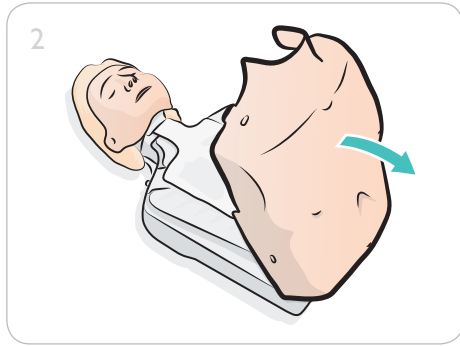
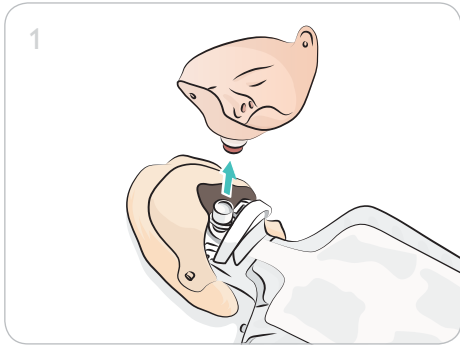



## Little Anne QCPR

## Little Anne QCPR

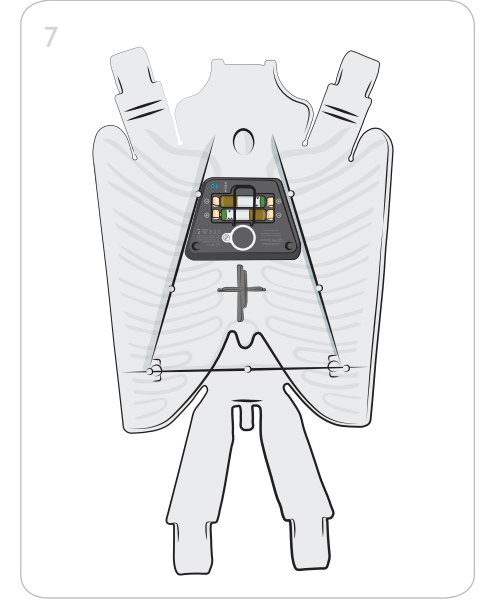
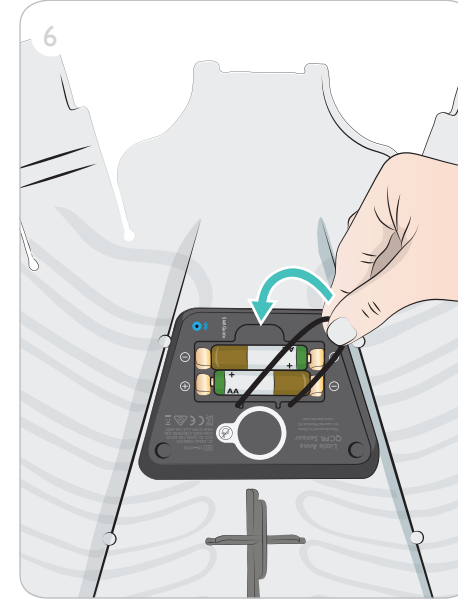
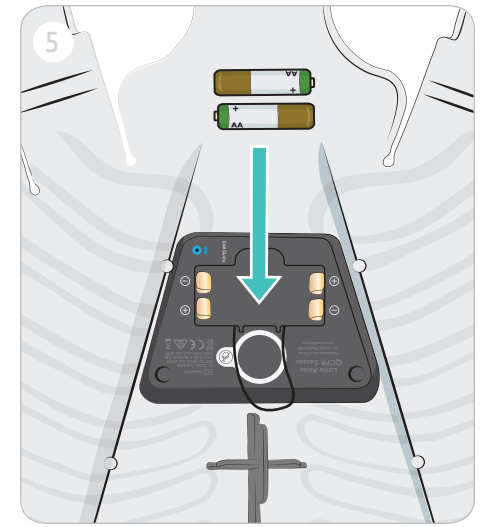
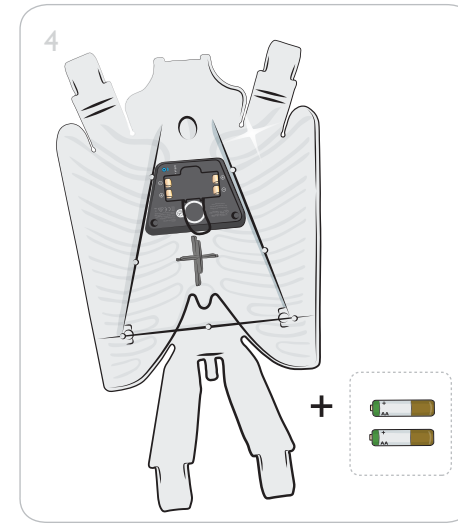
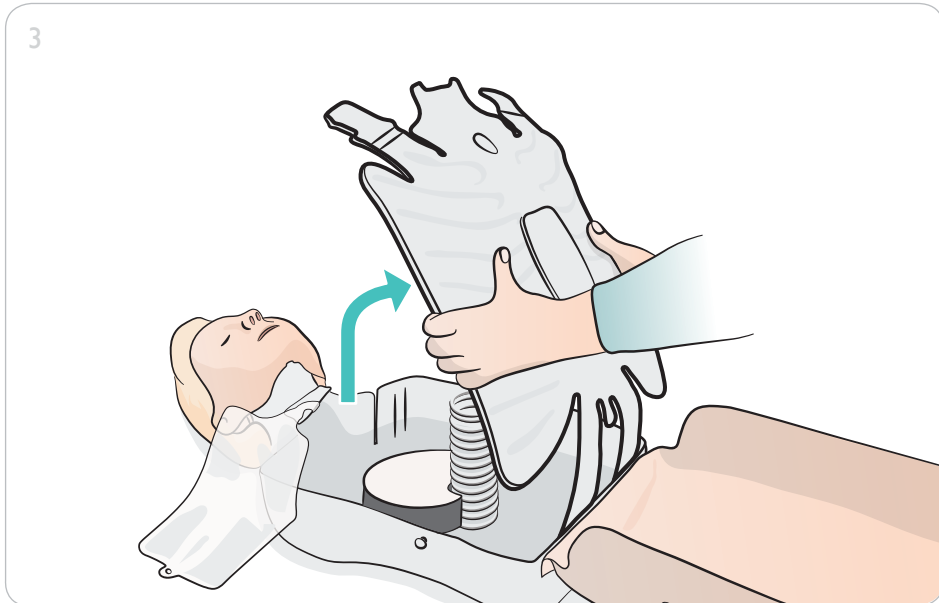
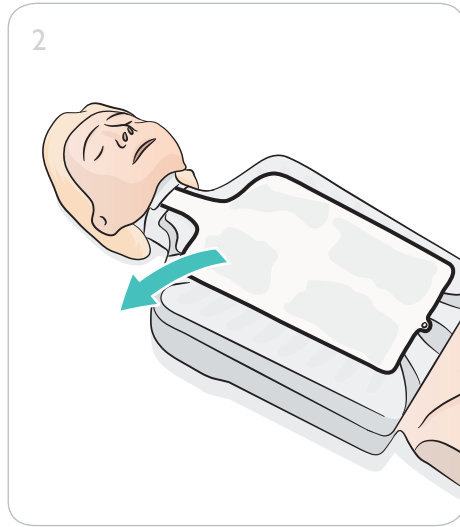
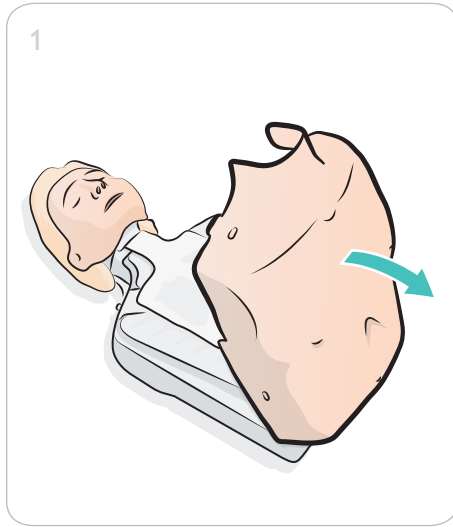

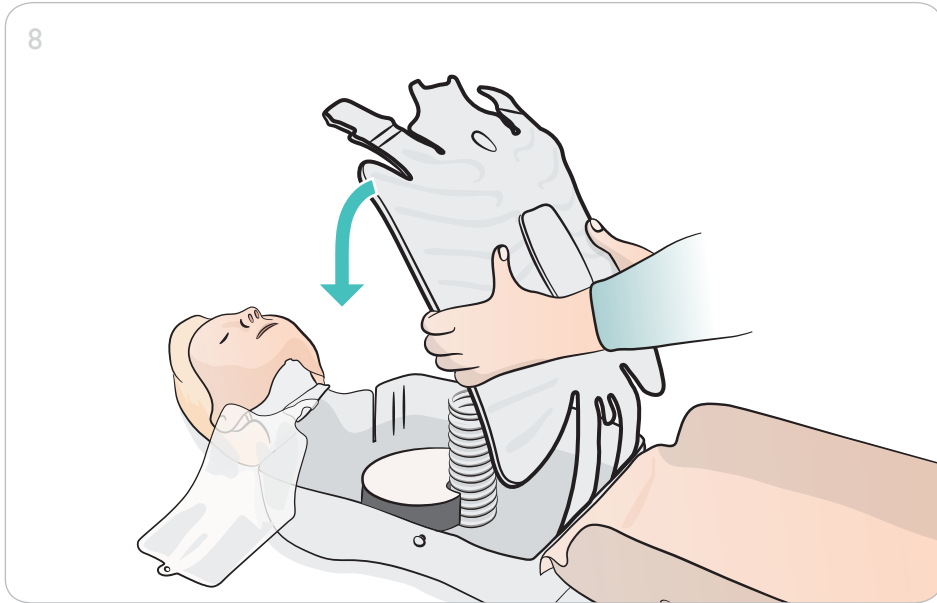

 Little Anne QCPR Instructor  
Little Anne QCPR Learner

 Little Anne QCPR Learner

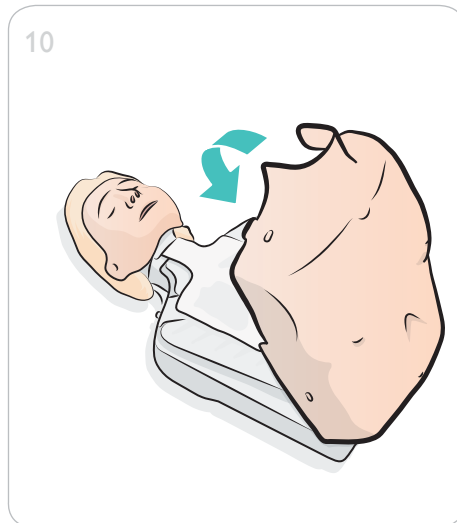
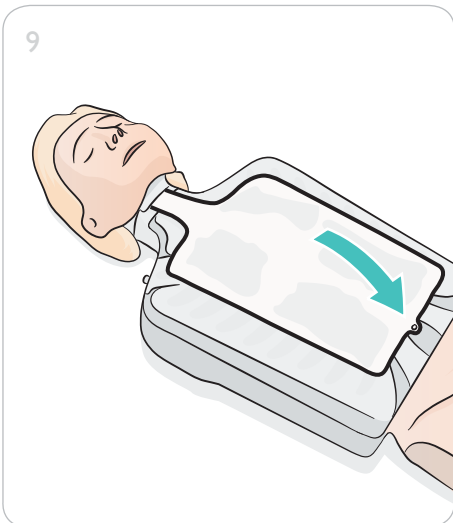

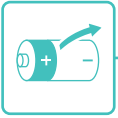

# Little Anne AED

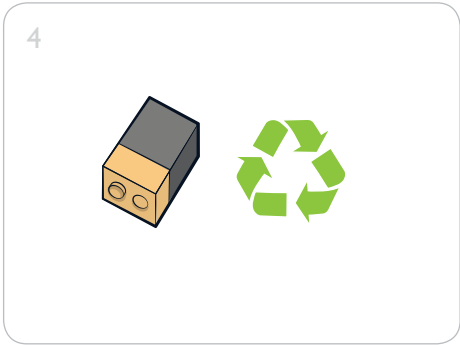
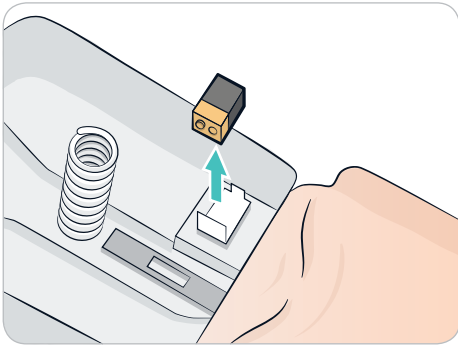
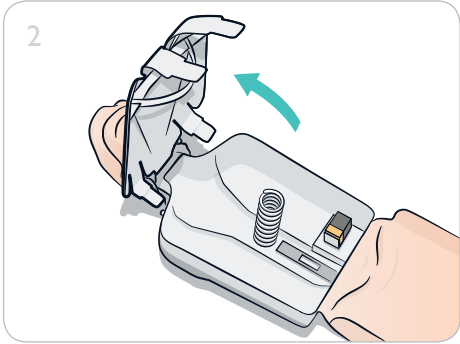
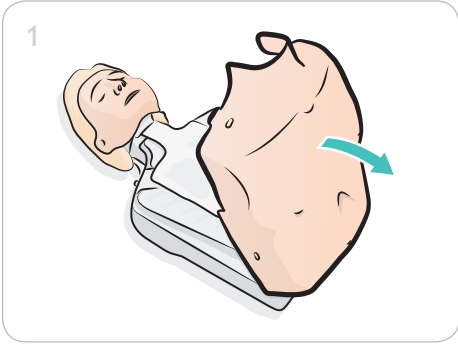

# Little Anne AED

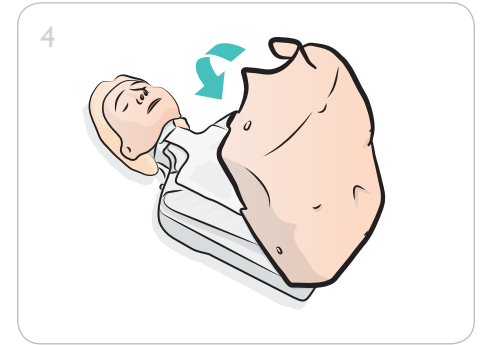
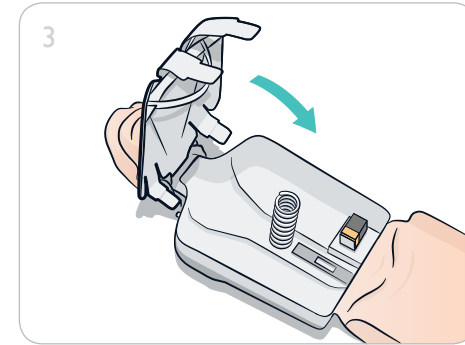
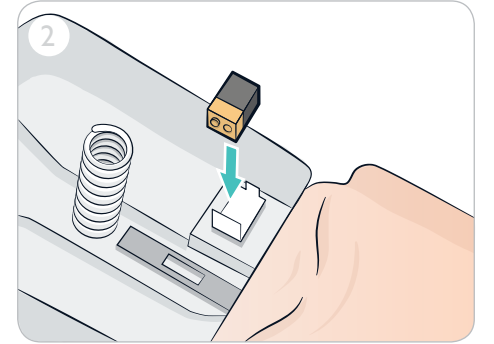
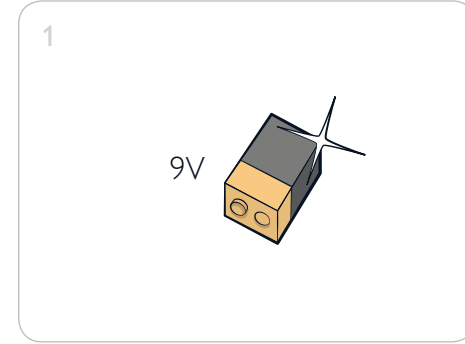
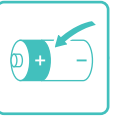

© 2017 Laerdal Medical AS. All rights reserved.  
Device Manufacturer: Laerdal Medical AS, P.O. Box 377,  
Tanke Svilandsgate 30, 4002 Stavanger, Norway  
T: (+47) 5151 1700

20-11797 Rev A

---

[www.laerdal.com](http://www.laerdal.com)



**Laerdal**  
helping save lives