

ZONDA
2TEN105

happy garden

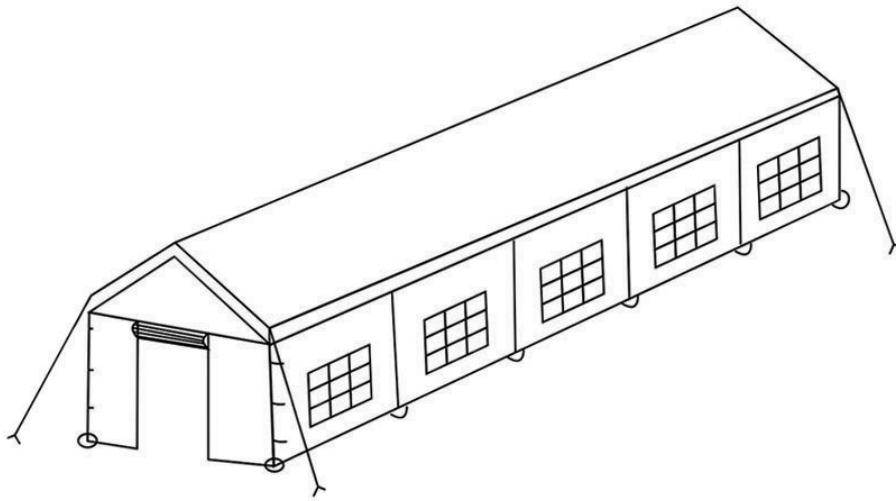

- FR** ATTENTION : cet article n'est pas une structure permanente.
Démonter et stocker dans un endroit sec en cas d'intempéries (fort vent, orage, tempête etc.)
- ES** ATENCIÓN: Este artículo no es una estructura permanente.
Desmontar y guardar en un lugar seco en caso de mal tiempo (viento fuerte, tormenta, etc.)
- EN** WARNING: This item is not a permanent structure.
Remove and store in a dry place in case of unfavourable weather (strong wind, storm, etc.)
- DE** ACHTUNG: Bei diesem Artikel handelt es sich nicht um eine dauerhafte Struktur.
Bei schlechtem Wetter (starker Wind, Gewitter, Sturm usw.) abbauen und an einem trockenen Ort lagern.
- NL** ATTENTIE: Dit artikel is geen permanente structuur.
Demonteren en op een droge plaats opbergen in geval van slecht weer (sterke wind, storm, enz.)
- IT** ATTENZIONE: questo articolo non è una struttura permanente.
Smontare e riporre in un luogo asciutto in caso di maltempo (vento forte, tempesta, ecc.).
- PT** ATENÇÃO: Este item não é uma estrutura permanente.
Desmontar e armazenar num local seco em caso de mau tempo (vento forte, tempestade, etc.)

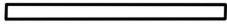

A x 12



B x 12



C x 15



D x 12

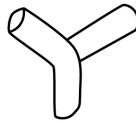

E x 6

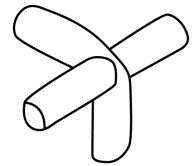

F x 12

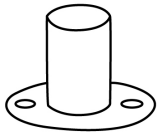

G x 12

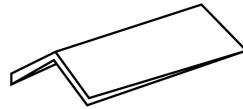

H x 1

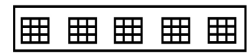

I x 2

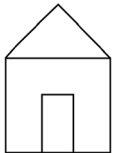

J x 2



K x 32

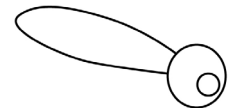

L x 72



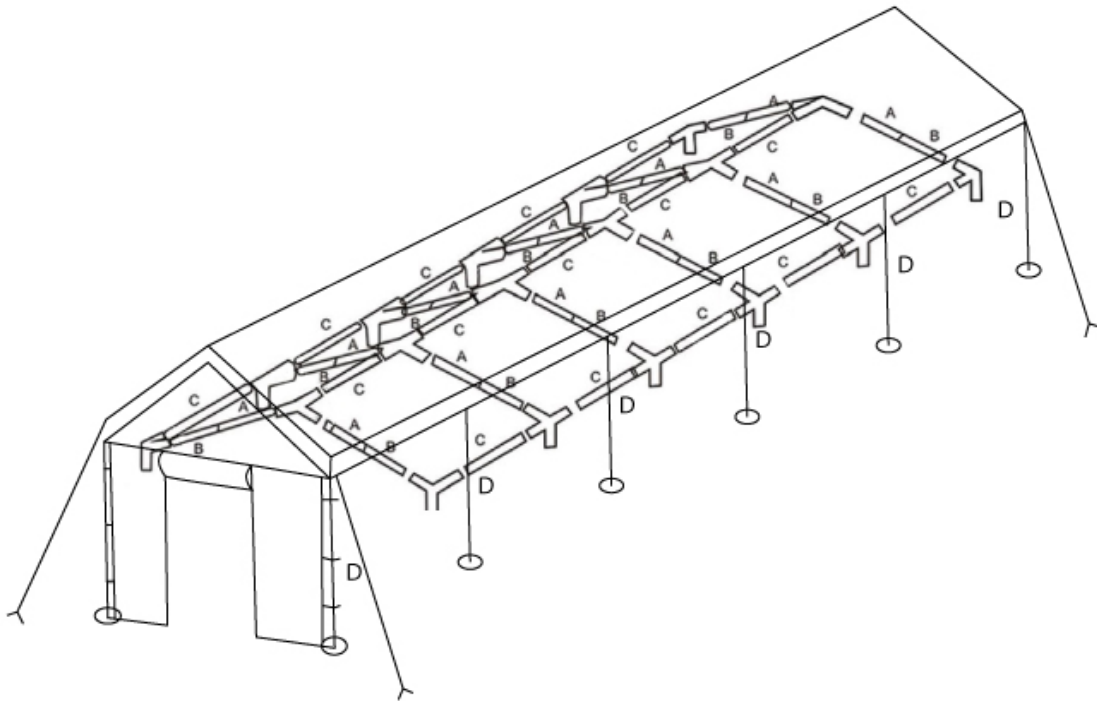

M x 8

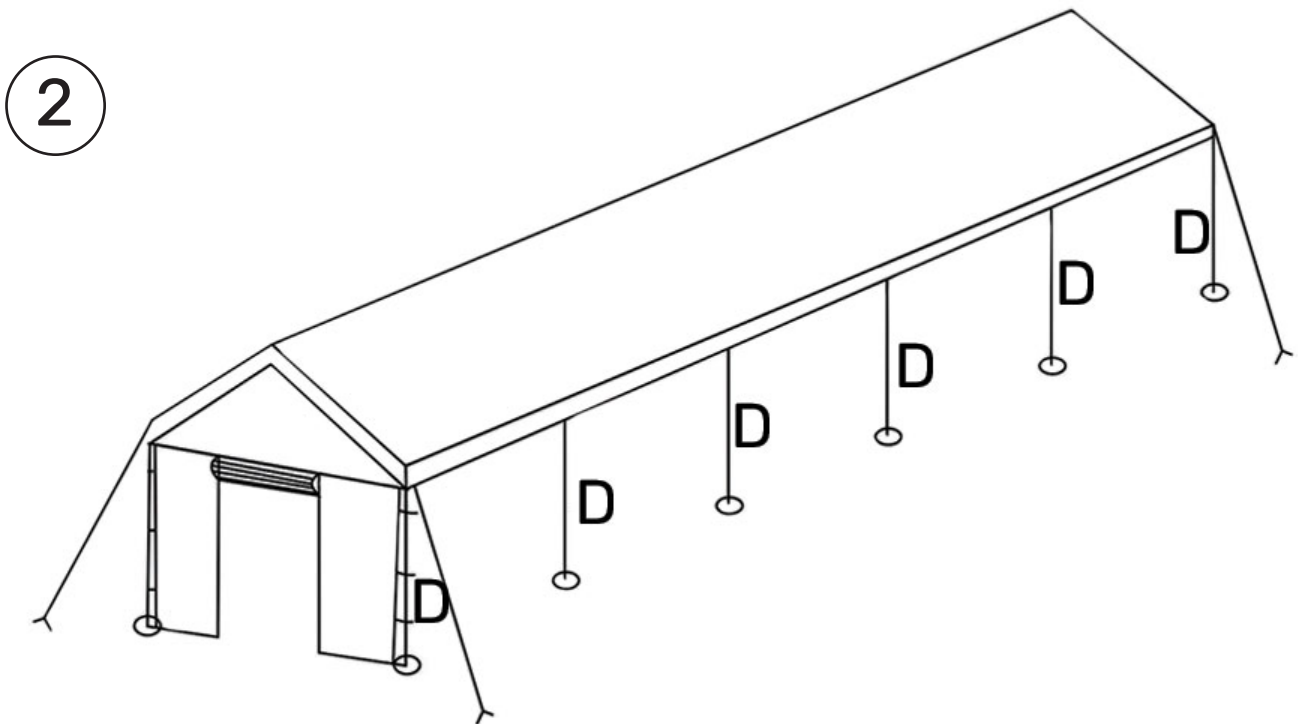
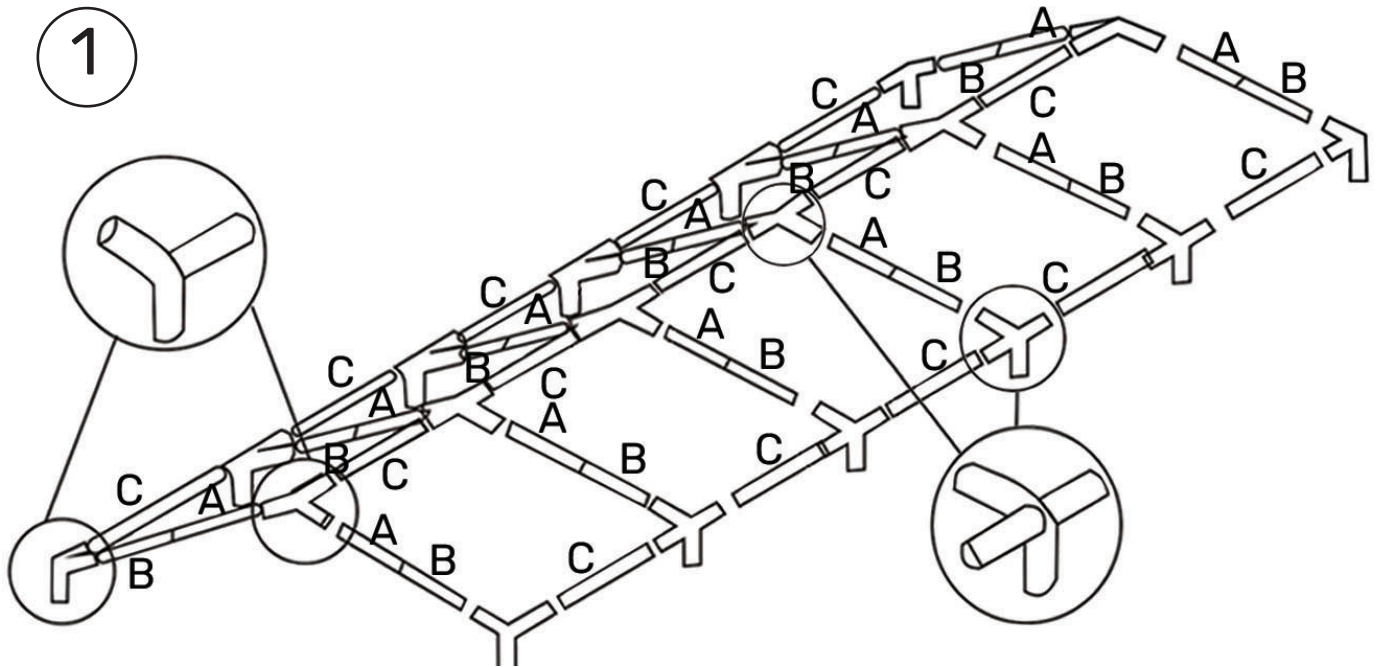

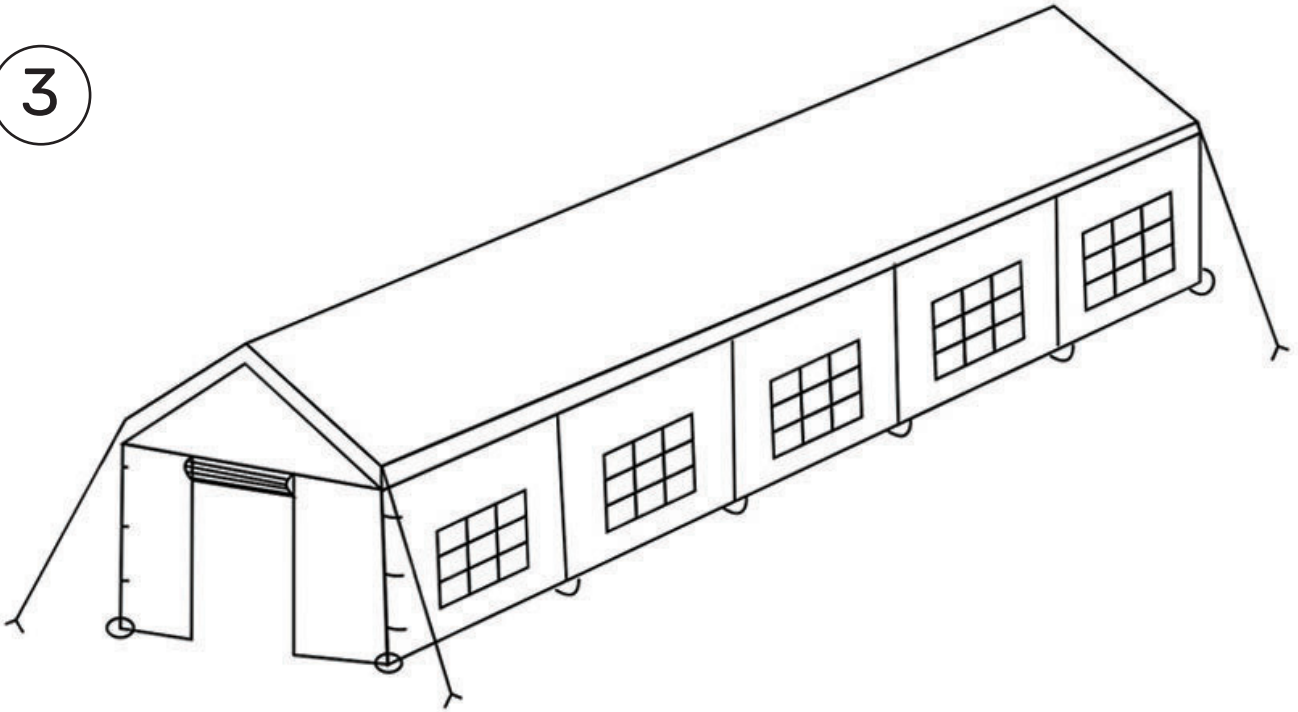

3



- 
- A large, stylized grey leaf icon is located in the top left corner of the page, partially overlapping the text area.
- FR** Veuillez conserver ce manuel pour référence ultérieure.
En cas de problème avec votre produit, nous vous invitons à contacter notre service client par mail à contact@happygarden.fr ou par téléphone au +33.3.20.267.567
- ES** Le rogamos conserve este manual de instrucciones para futuras consultas Si encuentra algún problema con su producto, le solicitamos que contacte con nuestro servicio de atención al cliente por correo electrónico: spv@happy-garden.es o por teléfono al 919 035 926
- EN** Please keep this manual for future reference.
If you have any problems with your product, please contact our customer service department by email at contact@happygarden.fr or by phone at +33.3.20.267.567
- DE** Bitte bewahren Sie diese Anleitung zum späteren Nachschlagen auf.
Falls Sie ein Problem mit Ihrem Produkt haben, wenden Sie sich bitte an unseren Kundenservice per E-Mail an contact@happygarden.fr oder telefonisch unter +33.3.20.267.567.
- NL** Bewaar deze handleiding voor toekomstig gebruik.
Indien u problemen heeft met uw product, neem dan contact op met onze klantendienst via e-mail op contact@happygarden.fr of per telefoon op +33.3.20.267.567
- IT** Si prega di conservare questo manuale per riferimento futuro.
In caso di problemi con il prodotto, si prega di contattare il nostro servizio clienti via e-mail a contact@happygarden.fr o per telefono al +33.3.20.267.567
- PT** Por favor, guarde este manual para referência futura.
Se tiver algum problema com o seu produto, contacte por favor o nosso departamento de serviço ao cliente através do e-mail contact@happygarden.fr ou por telefone para +33.3.20.267.567



happy garden

ALLSTORE SAS
121 allée Hélène Boucher
PA du Moulin
59118 WAMBRECHIES
FRANCE