

# TOM 315028i (NF)

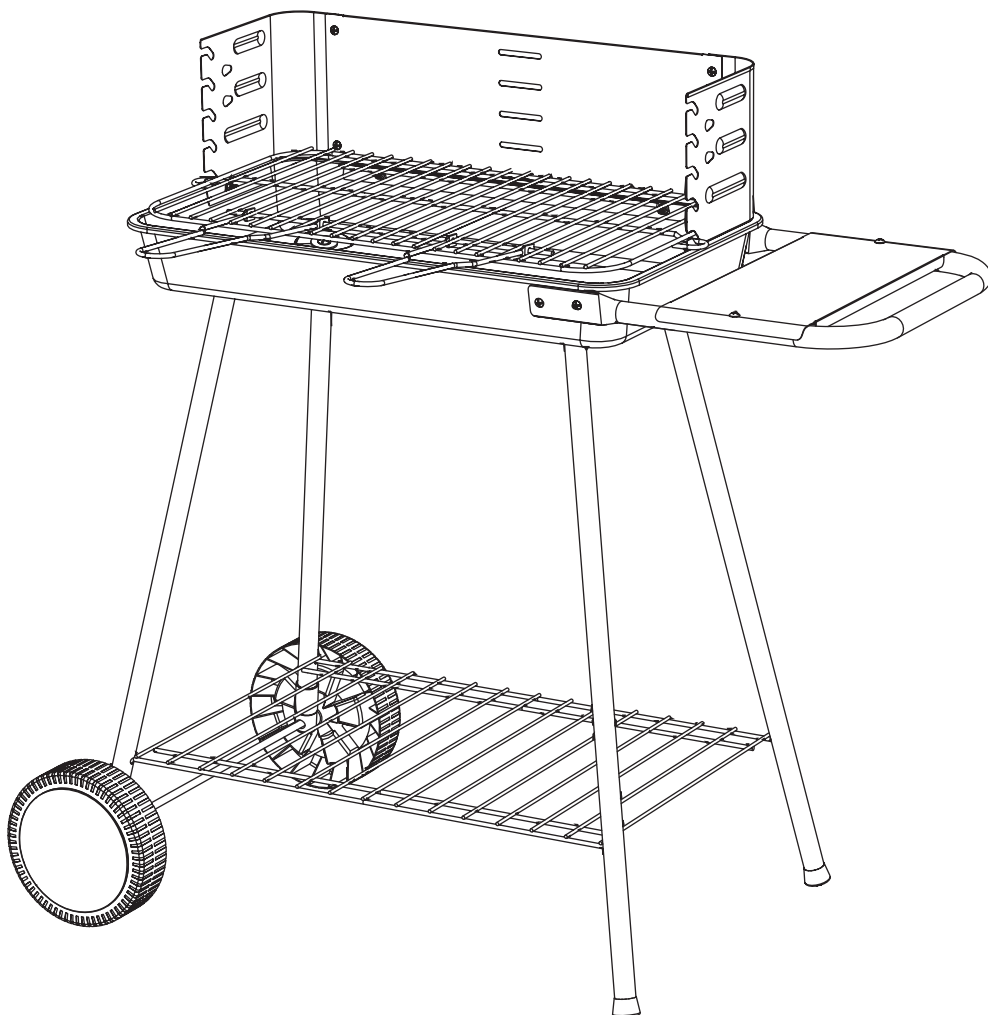

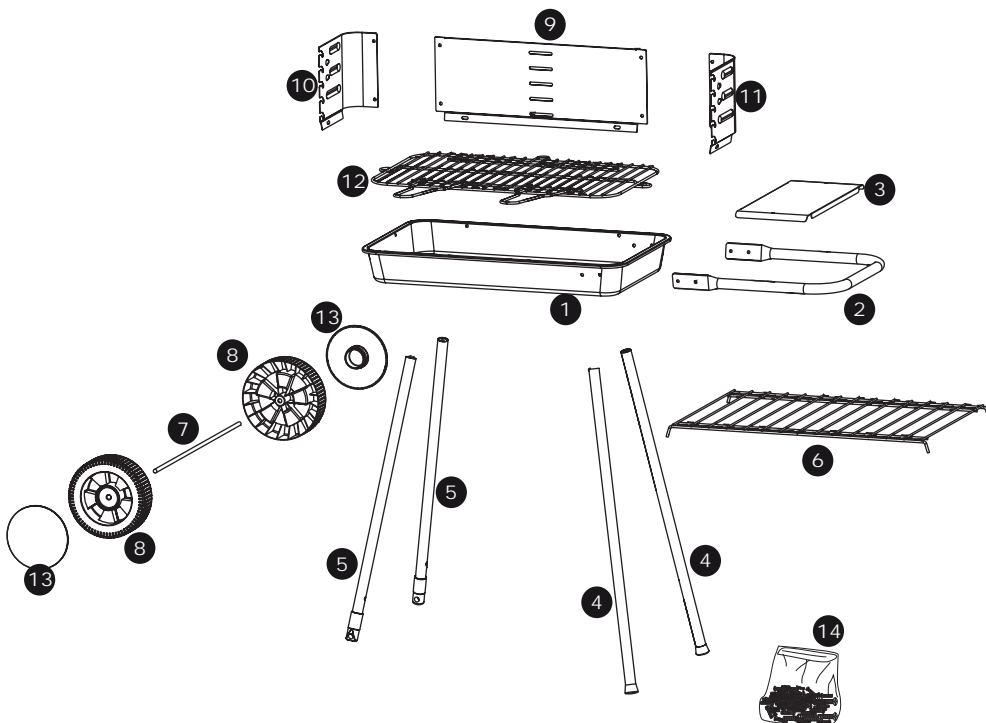

APPAREILS MÉNAGERS  
UTILISANT DES COMBUSTIBLES  
LIQUIDES OU SOLIDES

[www.marque-nf.com](http://www.marque-nf.com)











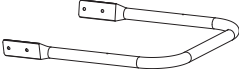
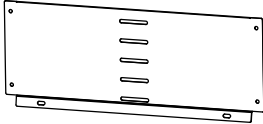
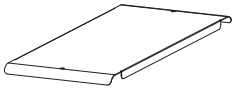
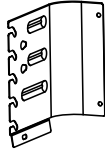

DOMESTIC APPLIANCES  
USING LIQUID OR SOLID FUELS

[www.marque-nf.com](http://www.marque-nf.com)

	3,5 x 9,5	2
	6 x 12	4
	4 x 12	8
	4 x 8	4
	Ø 45	4

	Ø 25	4
	Ø 8	2
	Ø 4	12
	Ø 4	12

1		x 1	8		x 2
2		x 1	9		x 1
3		x 1	10		x 1
4		x 2	11		x 1
5		x 2	12		x 1
6		x 1	13		x 2
7		x 1	14		x 1

- 1** 3,5 x 9,5    Ø4 x 12    Ø4    Ø4  
 x 2a        x 4b        x 4        x 4

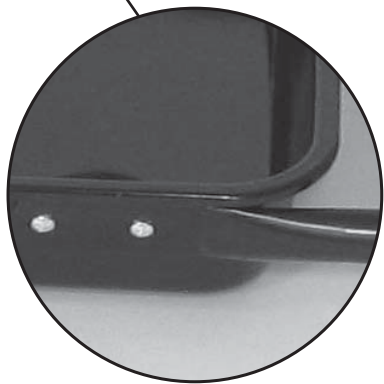
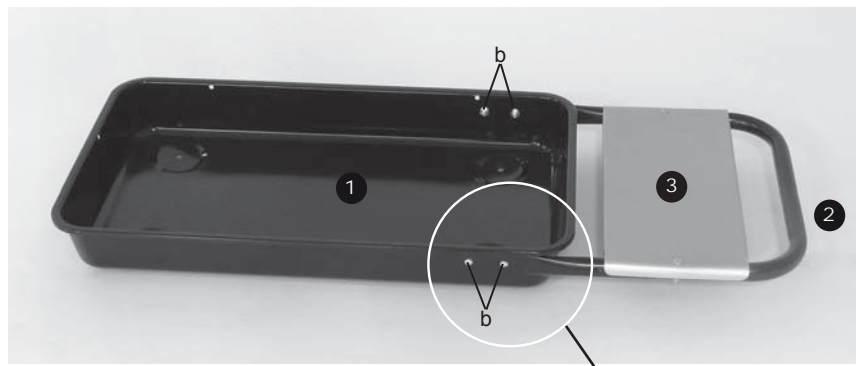

2

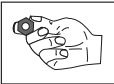
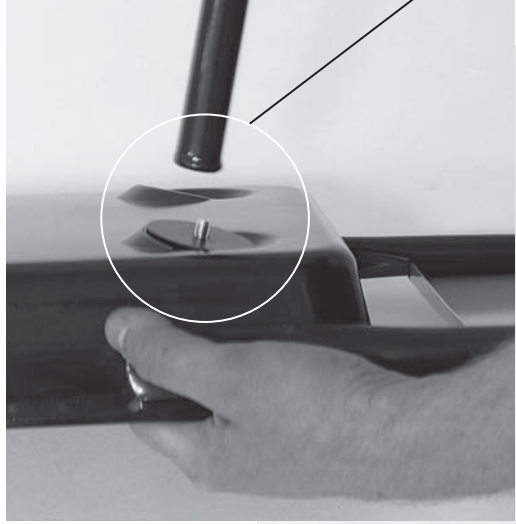
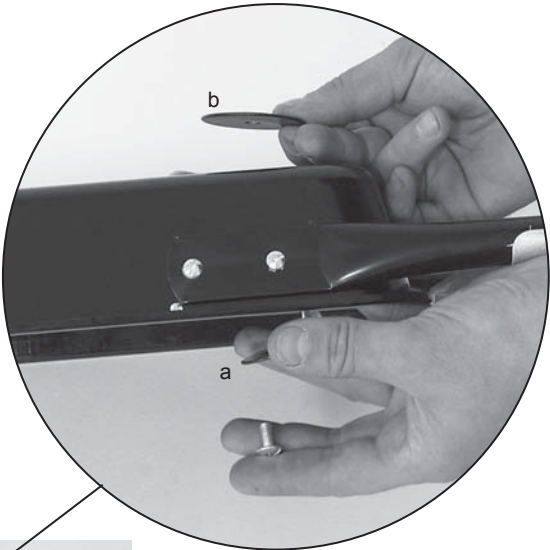
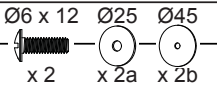

**3**  $\varnothing 6 \times 12$   $\varnothing 25$   $\varnothing 45$   
 x 2 x 2a x 2b

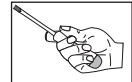
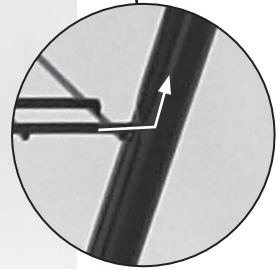
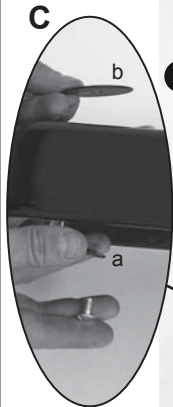
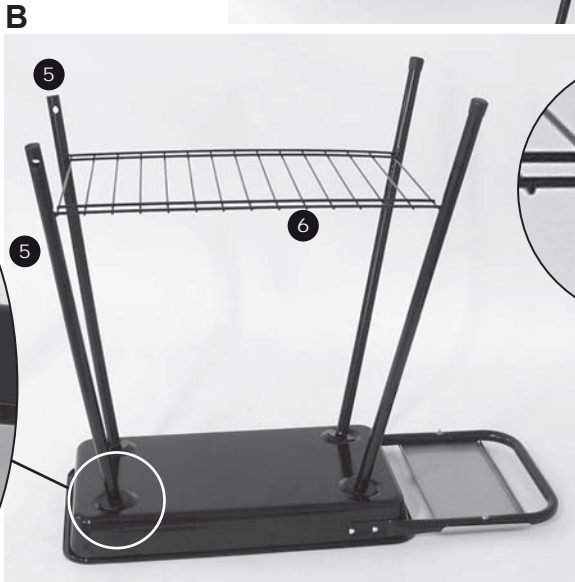
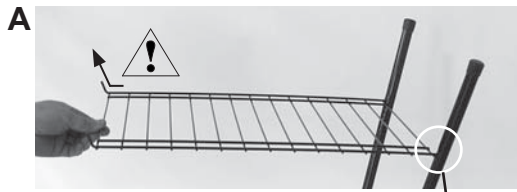

**4**  $\varnothing 8$  Nylstop

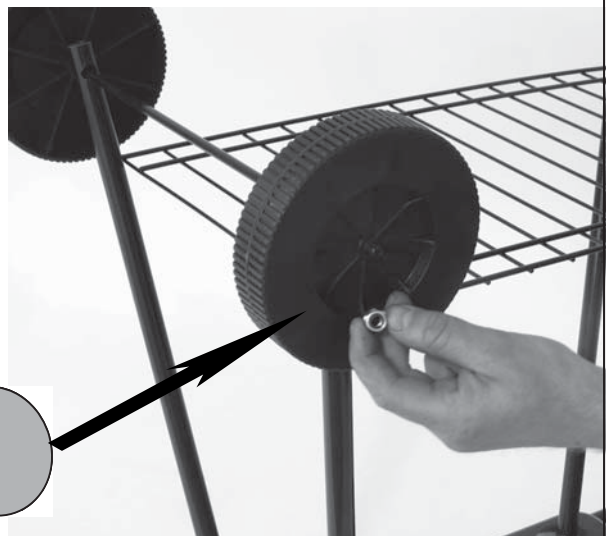
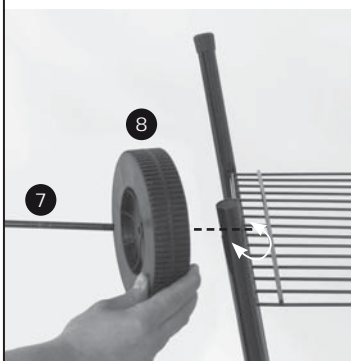

**5**  $\varnothing 4 \times 8$   $\varnothing 4$   $\varnothing 4$   
x 4 x 4 x 4

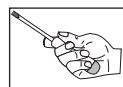
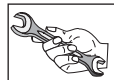
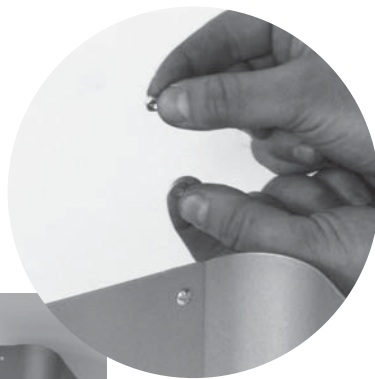

**6**  $\varnothing 4 \times 12$   $\varnothing 4$   $\varnothing 4$   
x 2 x 2 x 2

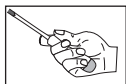
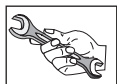
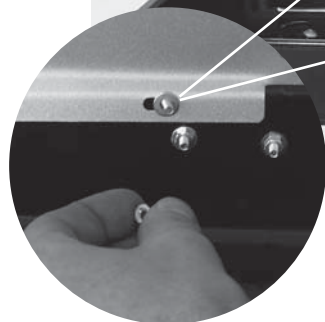
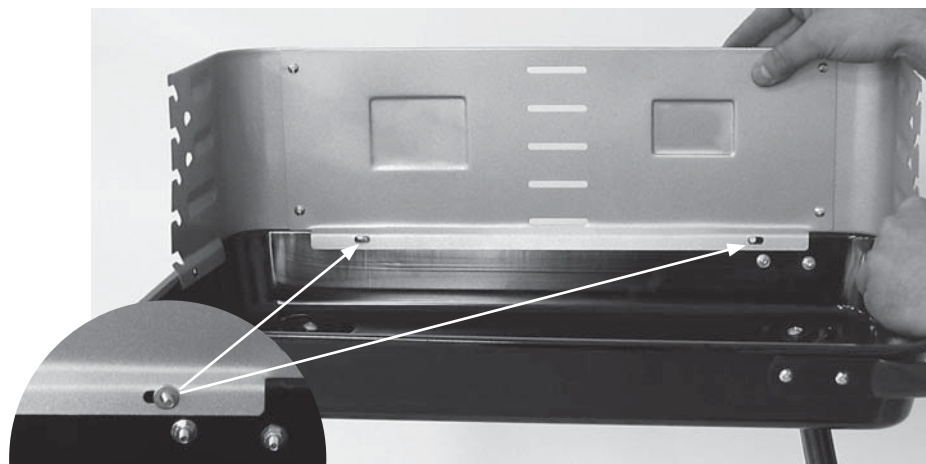

7

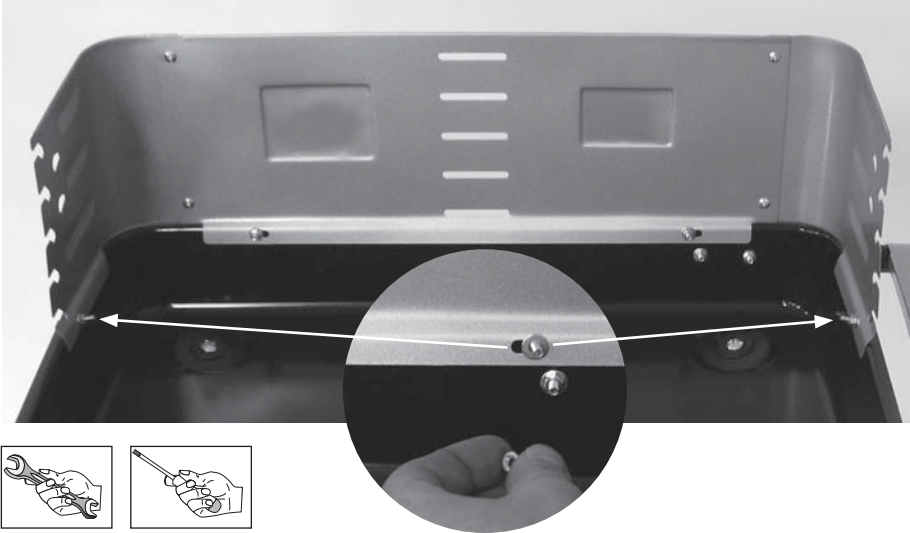
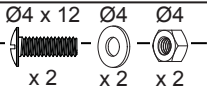

8

