

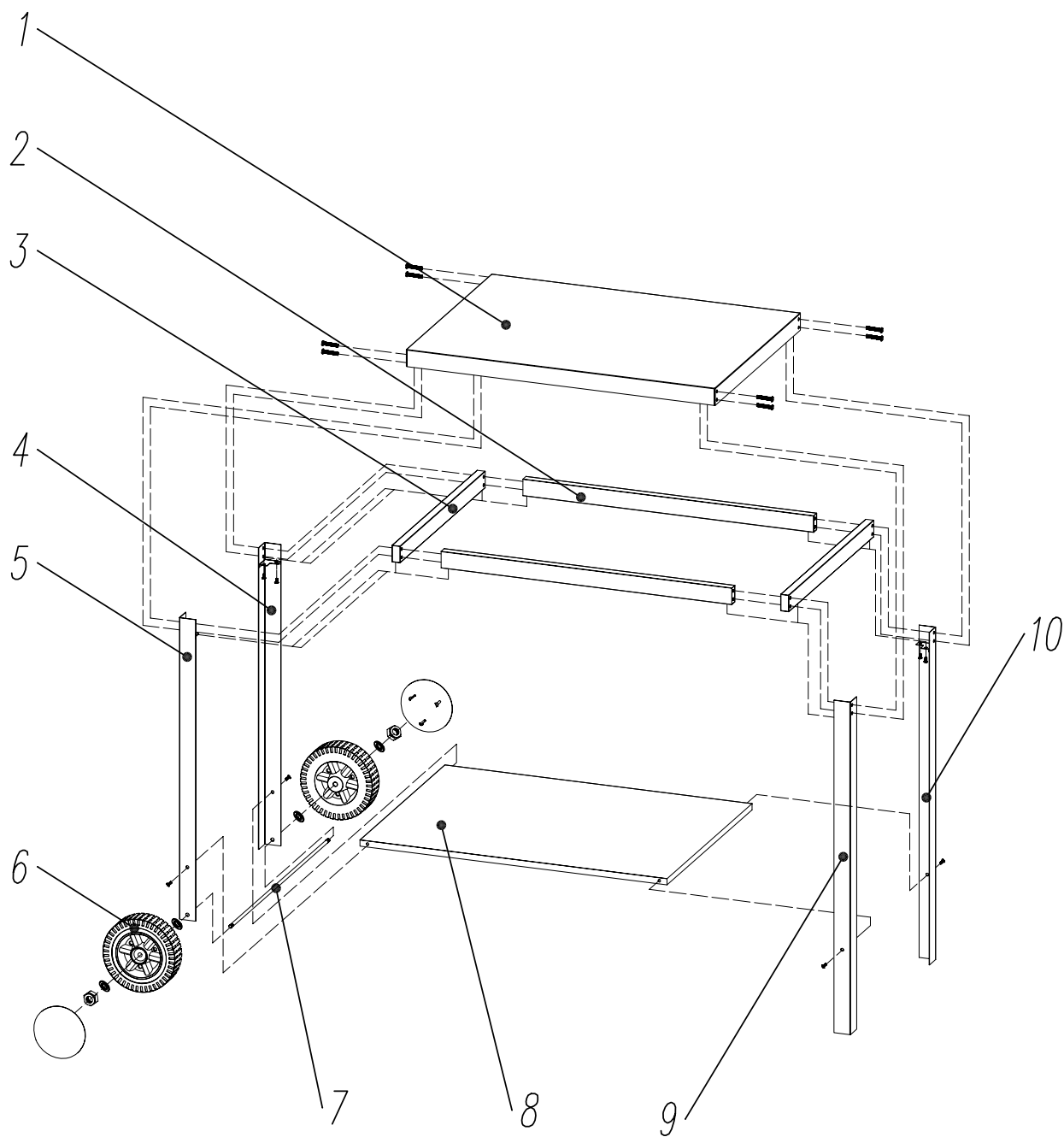

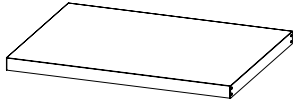



25min

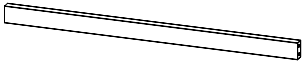
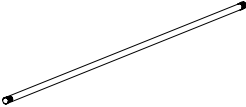
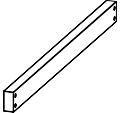
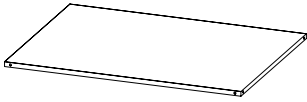
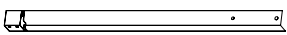
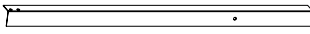
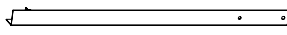
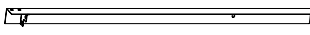

NO.	DESCRIPTION	QTY	NO.	DESCRIPTION	QTY
①		1	⑥		2
②		2	⑦		1
③		2	⑧		1
④		1	⑨		1
⑤		1	⑩		1
NO.	DESCRIPTION	SPEC	QTY		
A		M6 × 6	12		
B		M6 × 35	8		
C		M8	4		
D		M8	2		

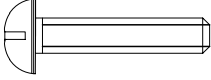
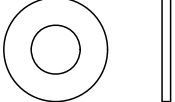