

JAMES
CONV07

happy garden

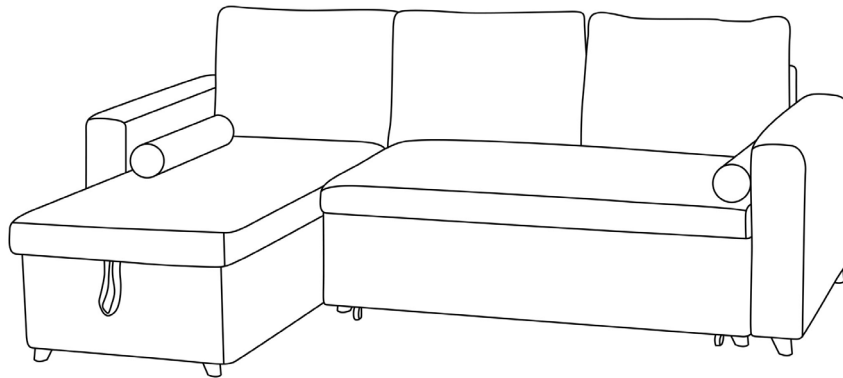



A x1

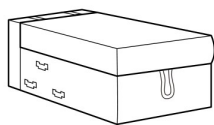

B x1

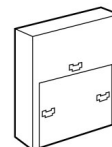

C x2

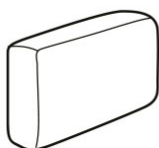

D x3

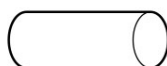

E x2



F x1



G x1



H x8



I x4



J x4

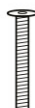

K x16



L x16



M x8



N x1

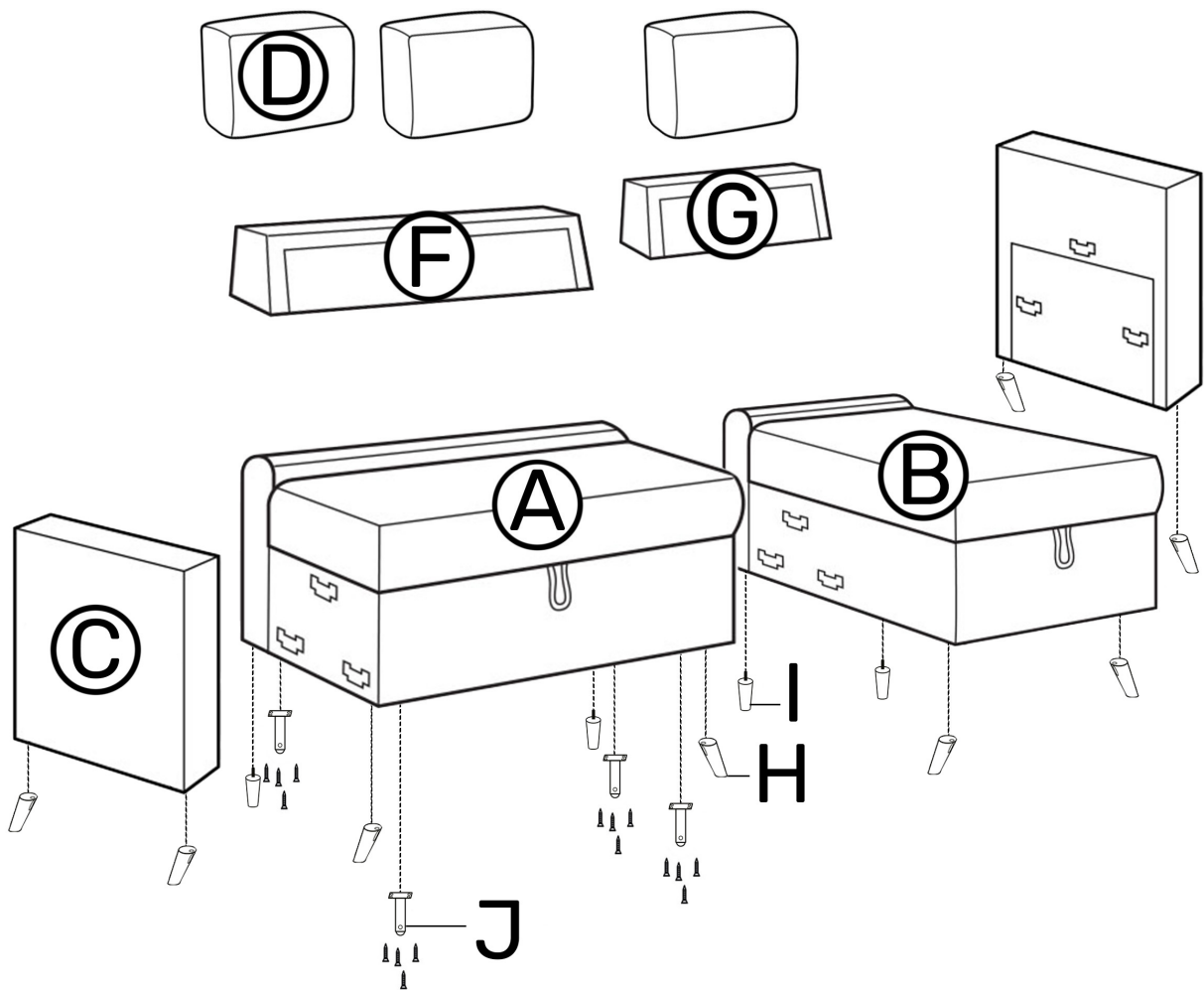

FR

Si vous souhaitez placer votre méridienne sur la **DROITE** du canapé, veuillez vous référer à ces instructions (2 personnes sont nécessaires pour l'assemblage du canapé) :

1

Vissez les pieds sur les accoudoirs, le canapé et la méridienne ainsi que les roulettes sur le tiroir à l'endroit indiqué.

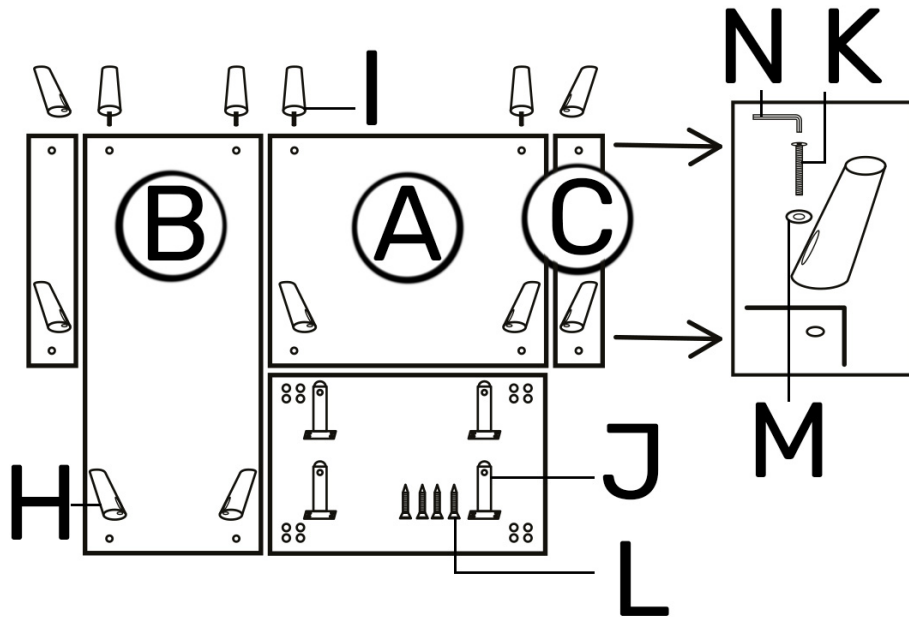

2

Attachez les accoudoirs avec le canapé et la méridienne

- Insérez l'accoudoir gauche sur le canapé du haut vers le bas,
- Insérez l'accoudoir droit sur la méridienne du bas vers le haut.

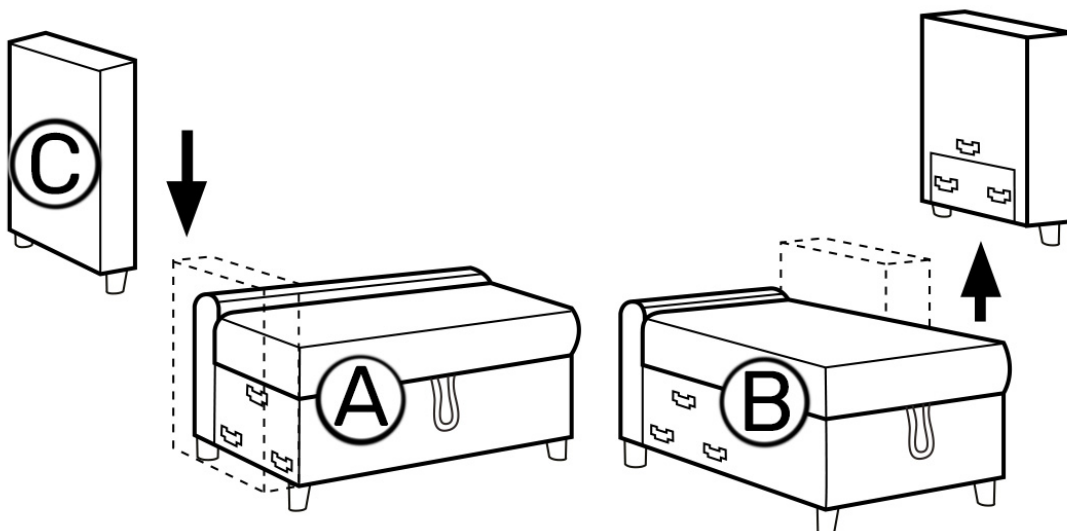

3

Attachez le canapé avec la méridienne.

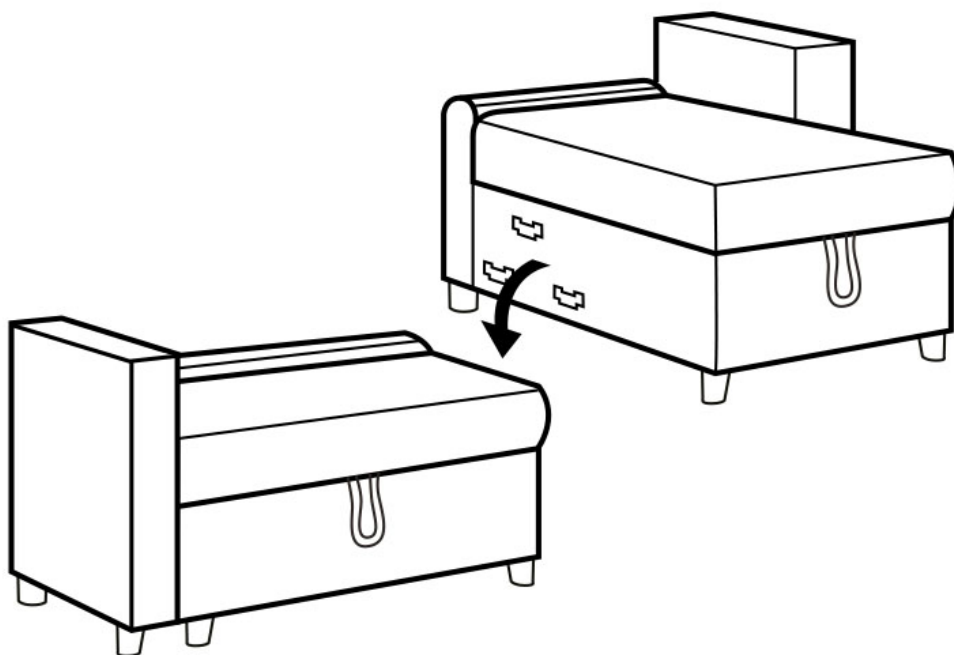

4

Faites glisser les deux dossiers dans les rails du canapé et de la méridienne.

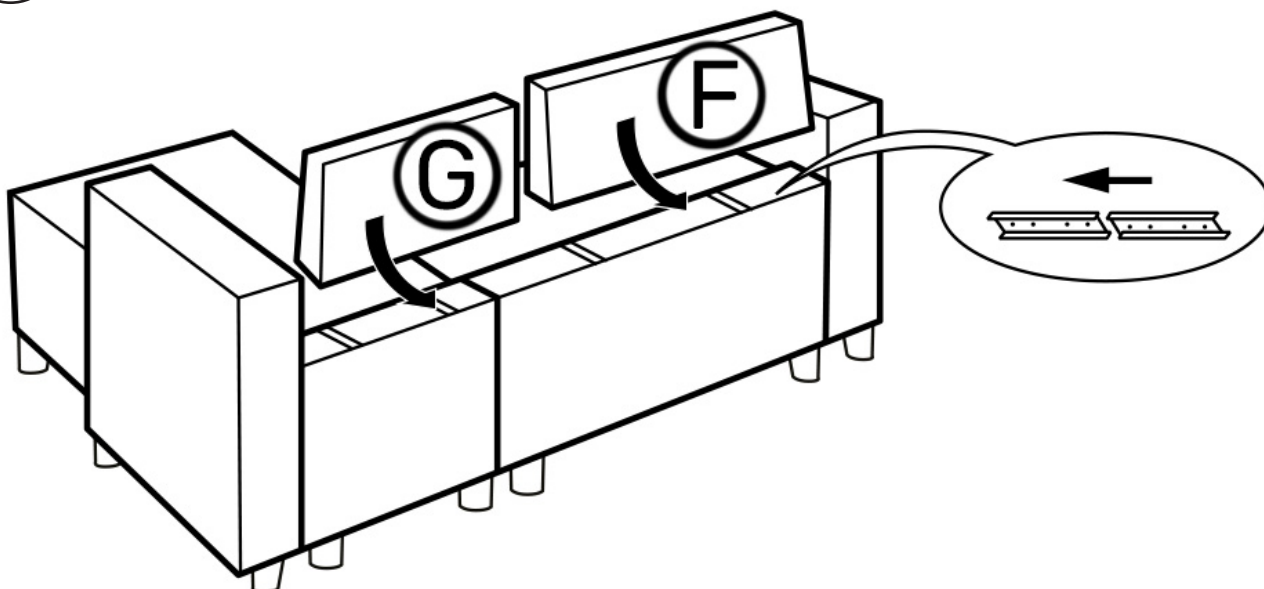

5

Pour accéder au coffre de rangement, soulevez l'assise de la méridienne.

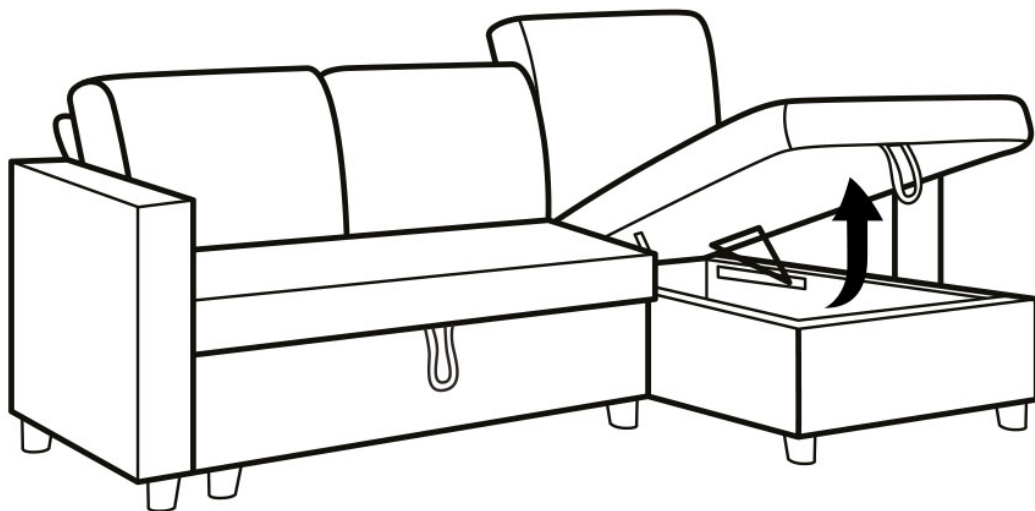

6

Pour déplier le lit, tirez sur la lanière et soulevez le couchage.

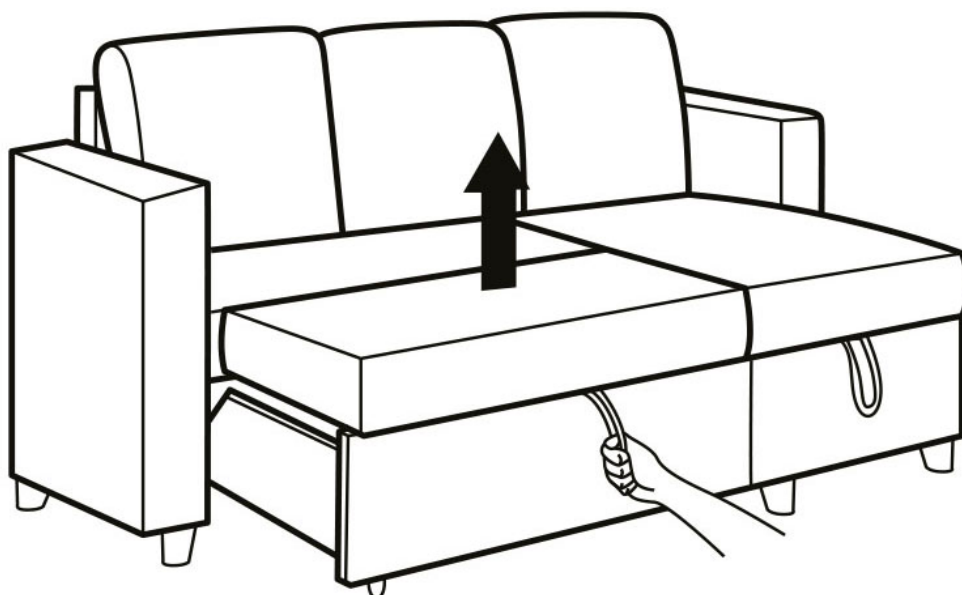

Si vous souhaitez placer votre méridienne sur la **GAUCHE** du canapé, veuillez vous référer à ces instructions (2 personnes sont nécessaires pour l'assemblage du canapé) :

1

Vissez les pieds sur les accoudoirs, la canapé et la méridienne ainsi que les roulettes sur le tiroir à l'endroit indiqué.

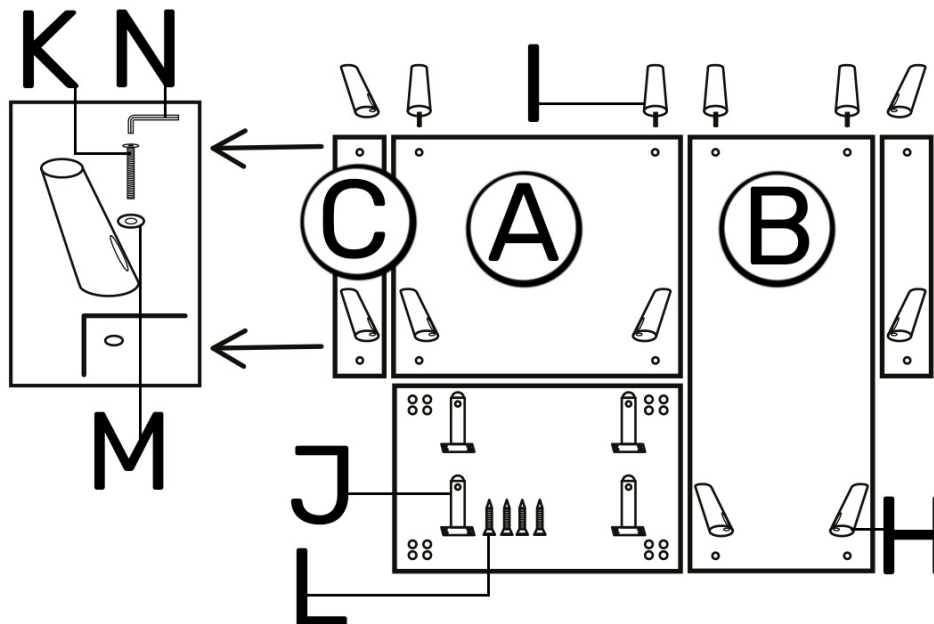

2

Attachez les accoudoirs avec le canapé et la méridienne

- Insérez l'accoudoir gauche sur la méridienne du haut vers le bas,
- Insérez l'accoudoir droit sur le canapé du bas vers le haut.

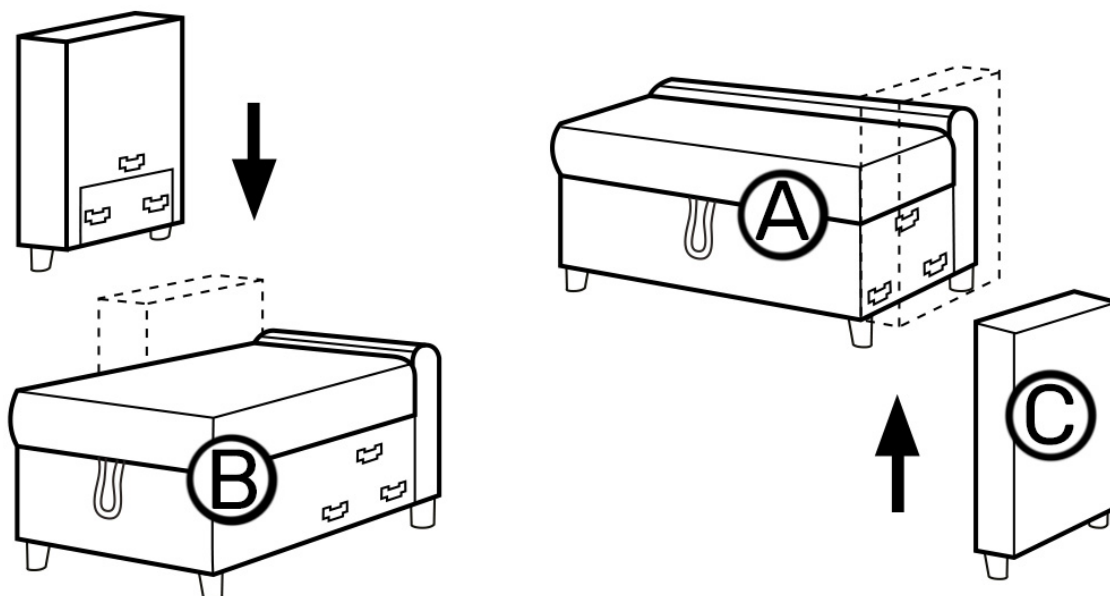

3

Attachez le canapé avec la méridienne.

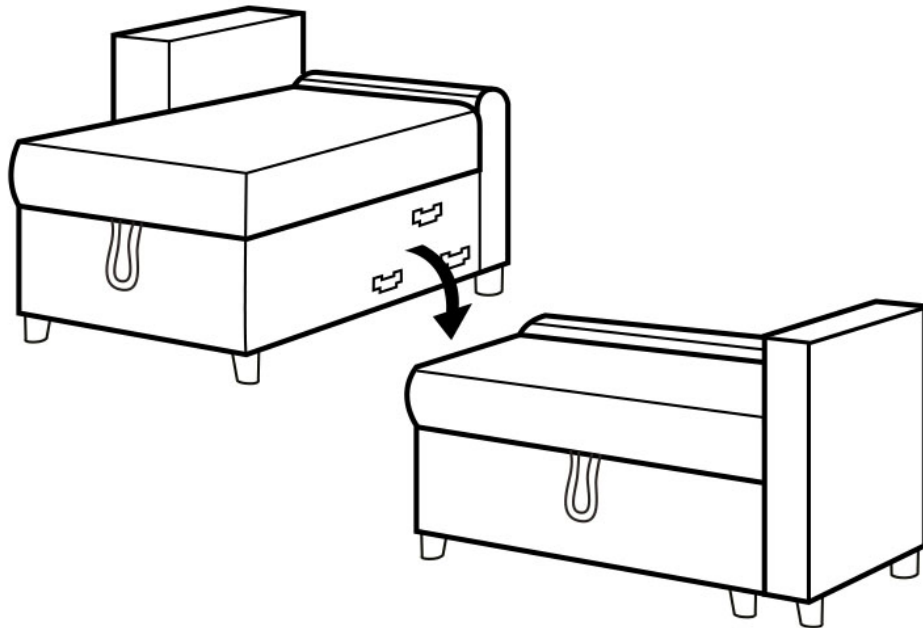

4

Faites glisser les deux dossiers dans les rails du canapé et de la méridienne.

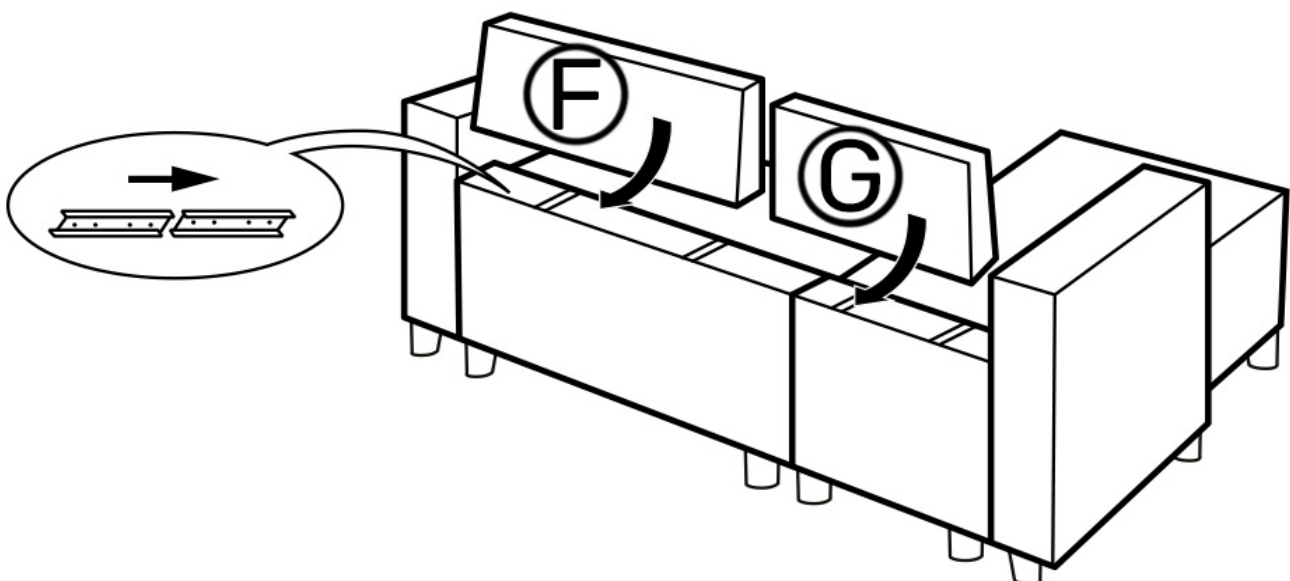

5

Pour accéder au coffre de rangement, soulevez l'assise de la méridienne.

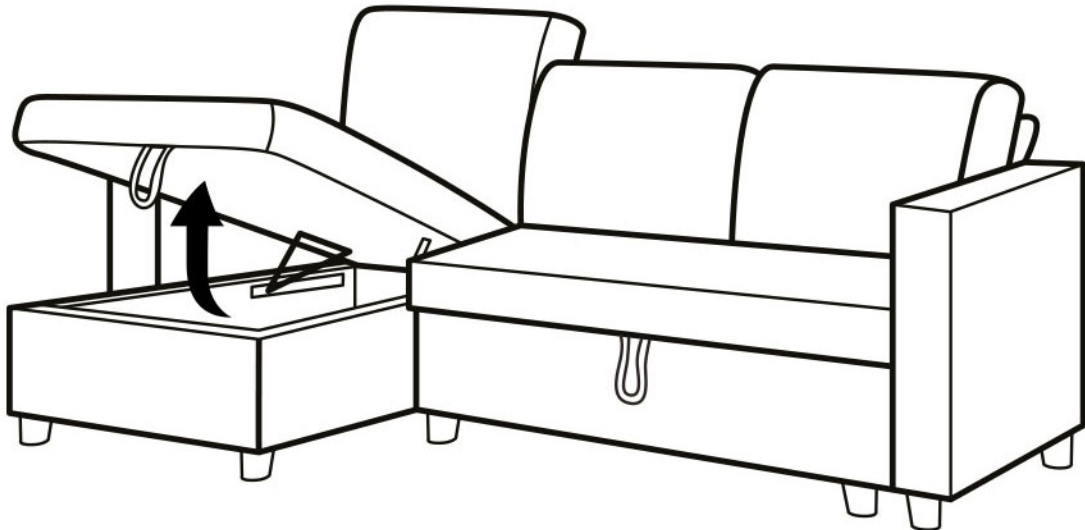

6

Pour déplier le lit, tirez sur la lanière et soulevez le couchage.

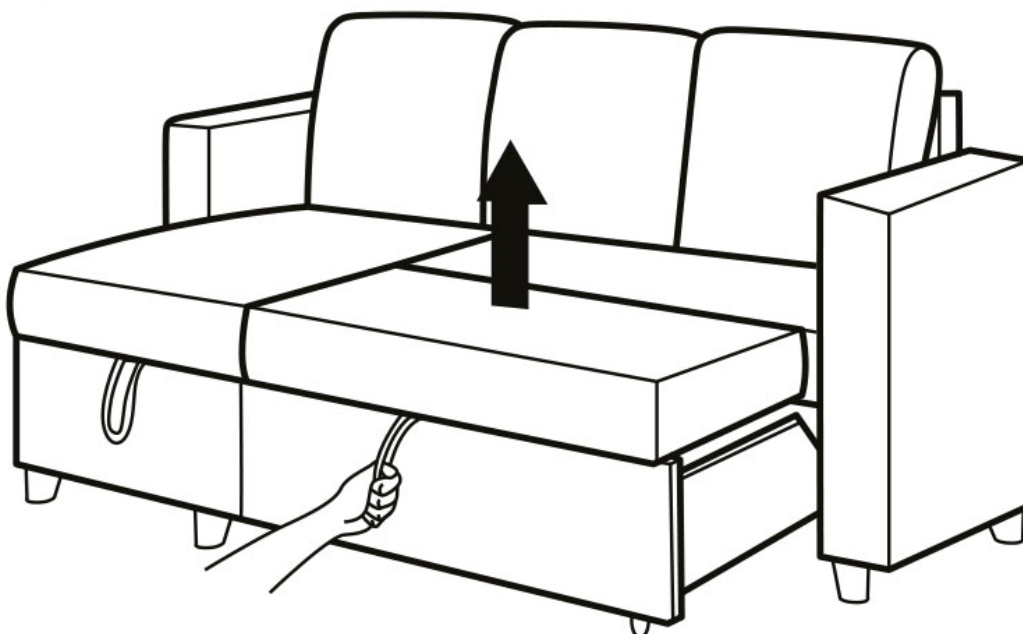

ES

Si desea colocar su sofá en el lado **DERECHO** del mismo, consulte estas instrucciones (se necesitan 2 personas para montar el sofá):

1

Atornille las patas a los reposabrazos, al sofá y a la chaise longue y las ruedas al cajón en la posición indicada.

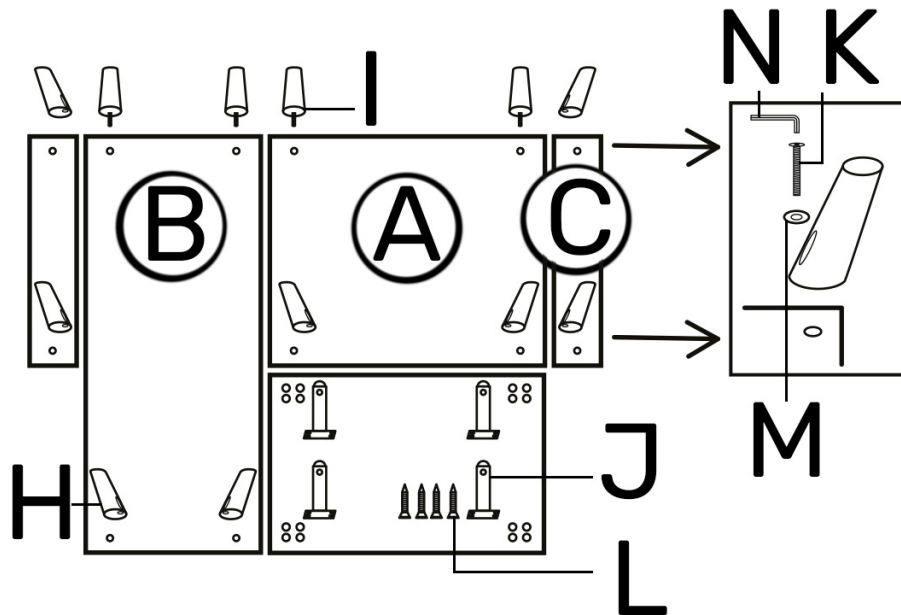

2

Fije los reposabrazos al sofá y al asiento

- Introduzca el reposabrazos izquierdo en el sofá de arriba a abajo,
- Inserte el reposabrazos derecho en el sofá desde abajo hacia arriba.

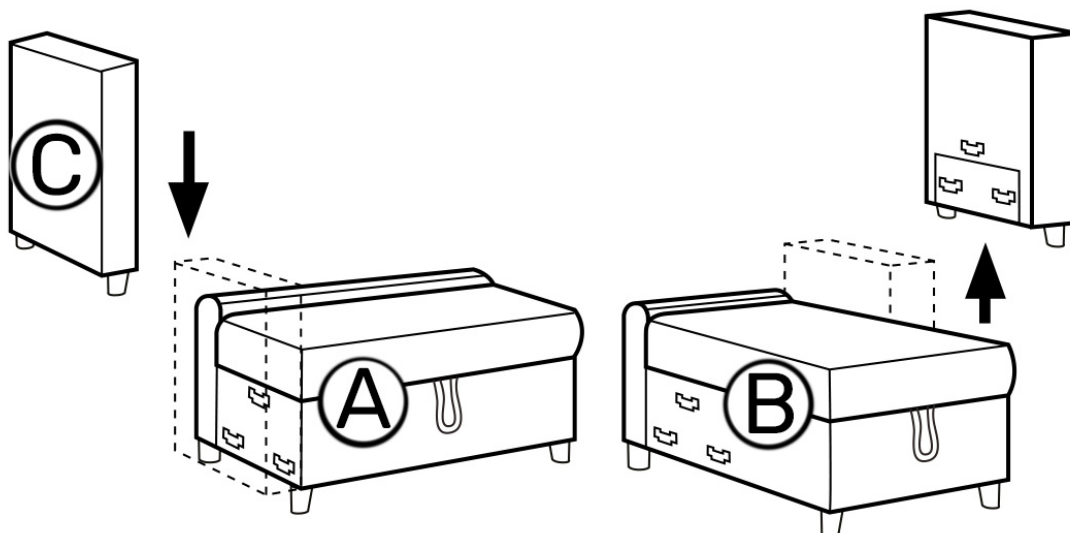

3

Fije el sofá al asiento.

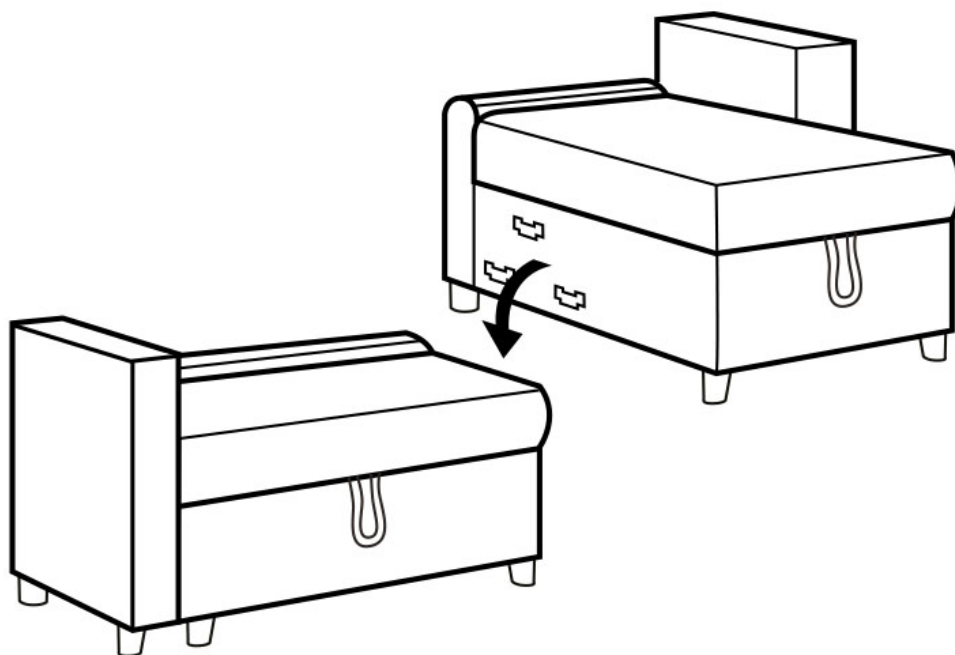

4

Deslice los dos respaldos en los raíles del sofá y del asiento.

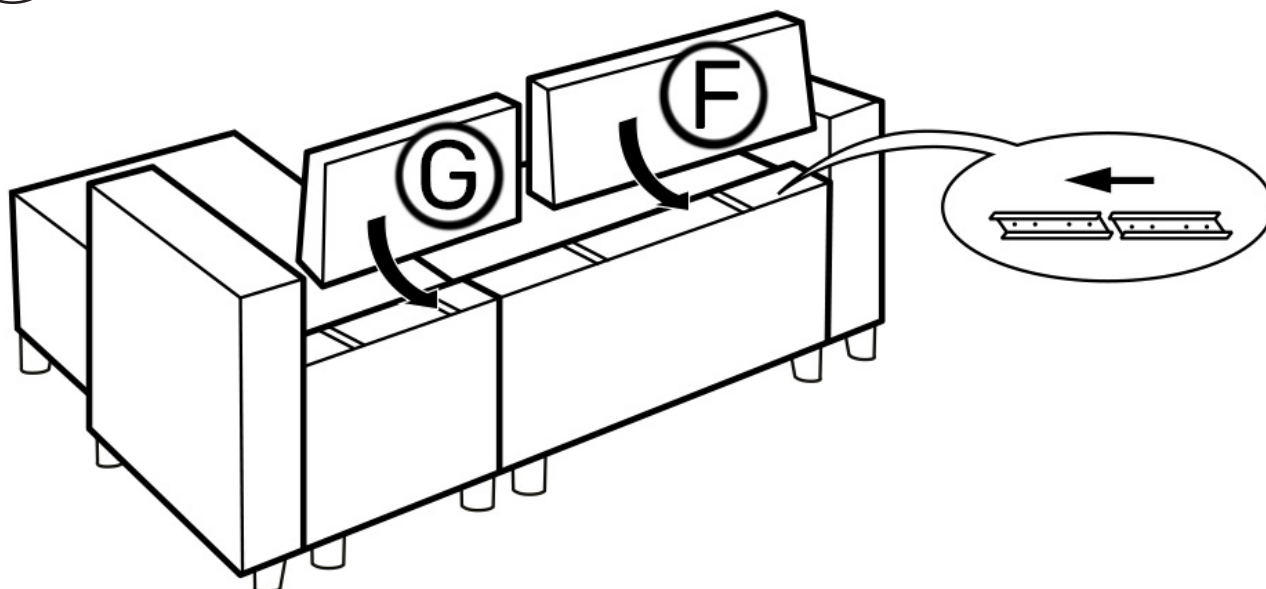

5

Para acceder a la caja de almacenamiento, levante el asiento del sofá.

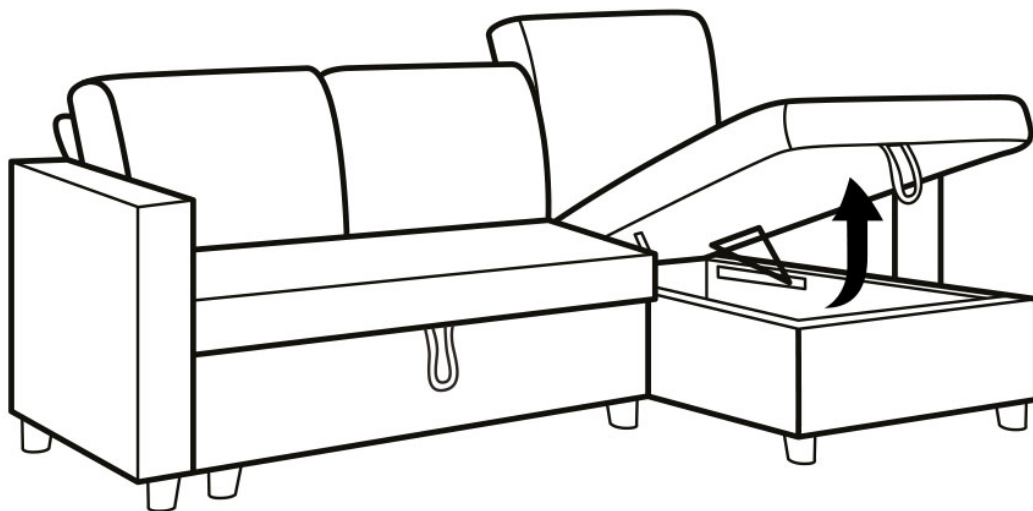

6

Para desplegar la cama, tire de la correa y levántela.

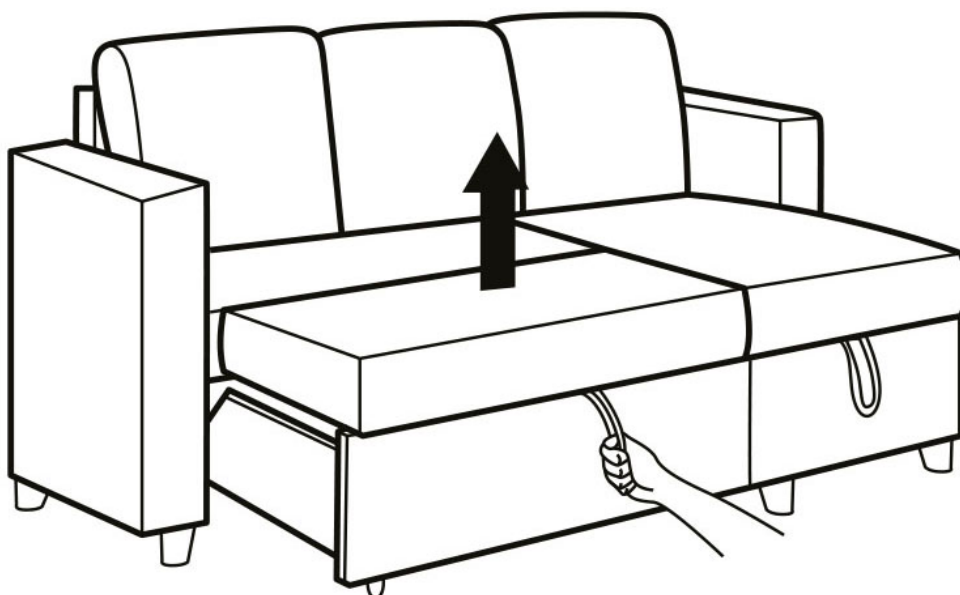

Si desea colocar su sofá en el lado **IZQUIERDO** del mismo, consulte estas instrucciones (se necesitan 2 personas para montar el sofá):

1

Atornille las patas a los reposabrazos, al sofá y a la chaise longue y las ruedas al cajón en la posición indicada.

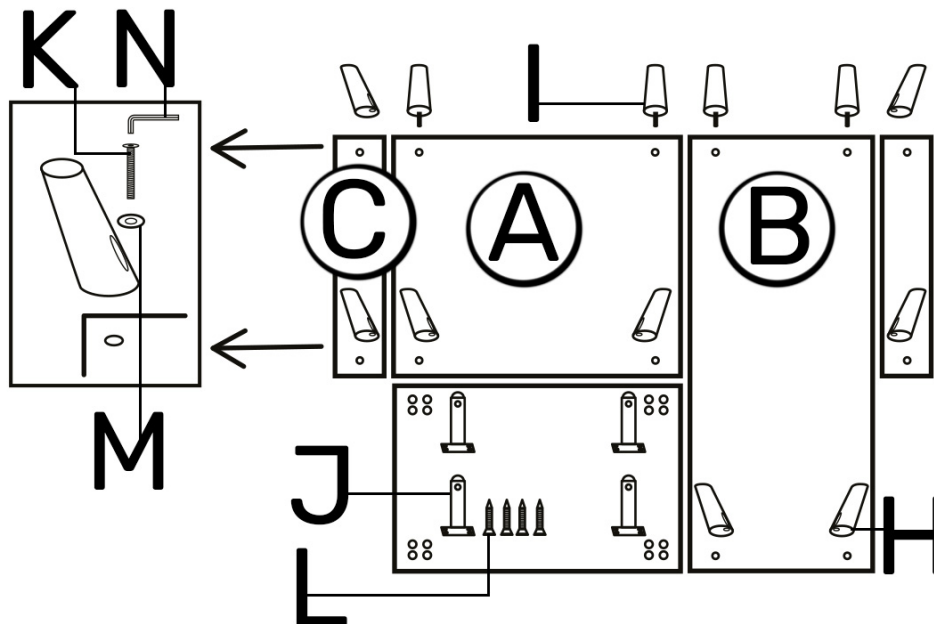

2

Fije los reposabrazos al sofá y a la chaise longue

- Introduzca el reposabrazos izquierdo en el sofá de arriba a abajo,
- Inserte el reposabrazos derecho en el sofá desde abajo hacia arriba.

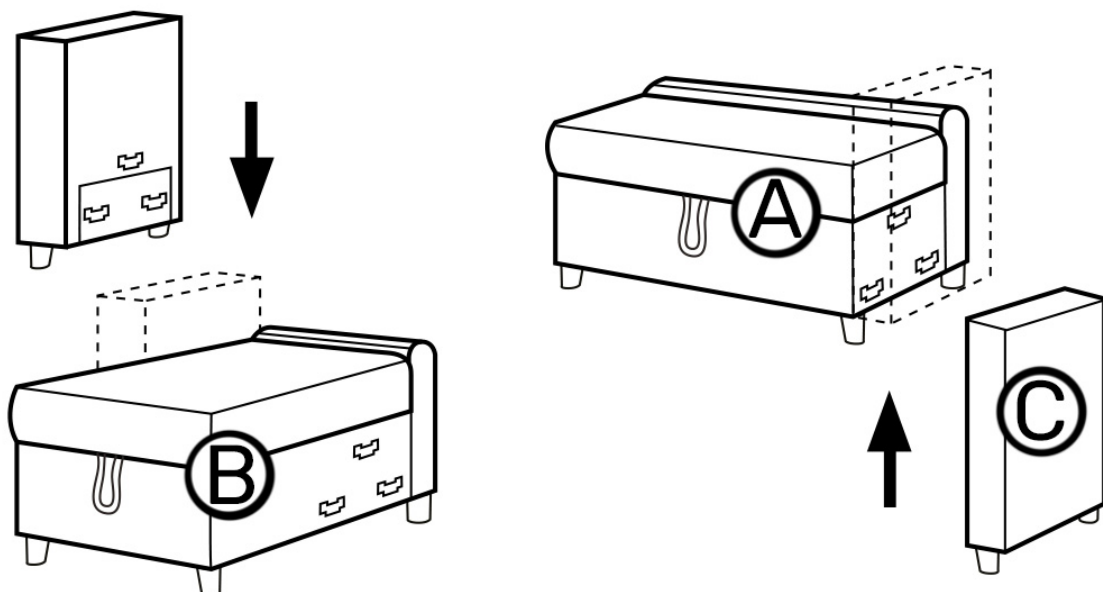

3

Fije el sofá al asiento.

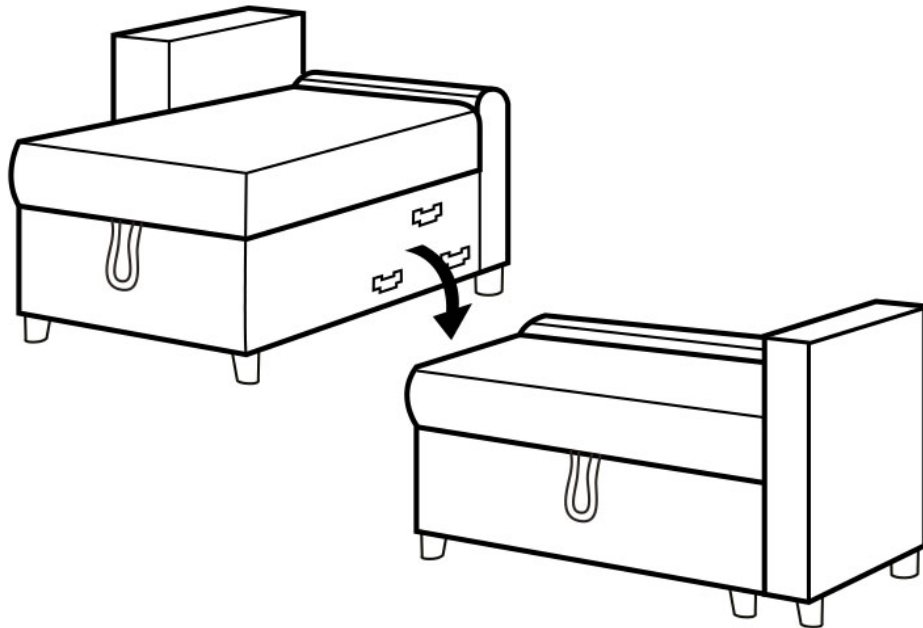

4

Deslice los dos respaldos en los raíles del sofá y del asiento.

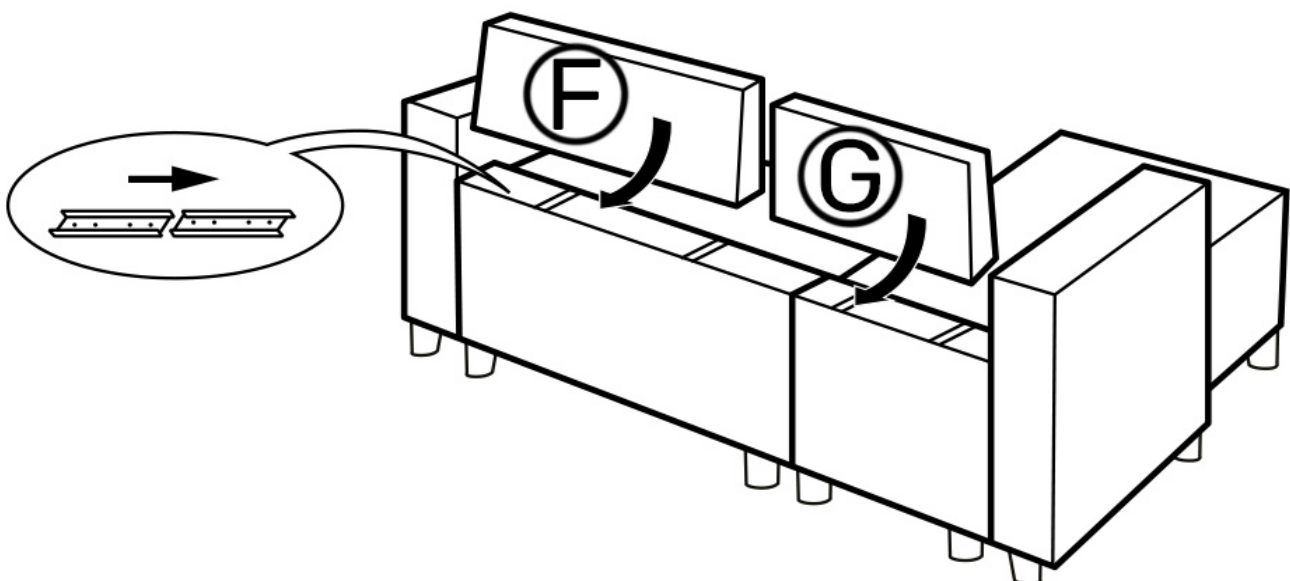

5

Para acceder a la caja de almacenamiento, levante el asiento del sofá.

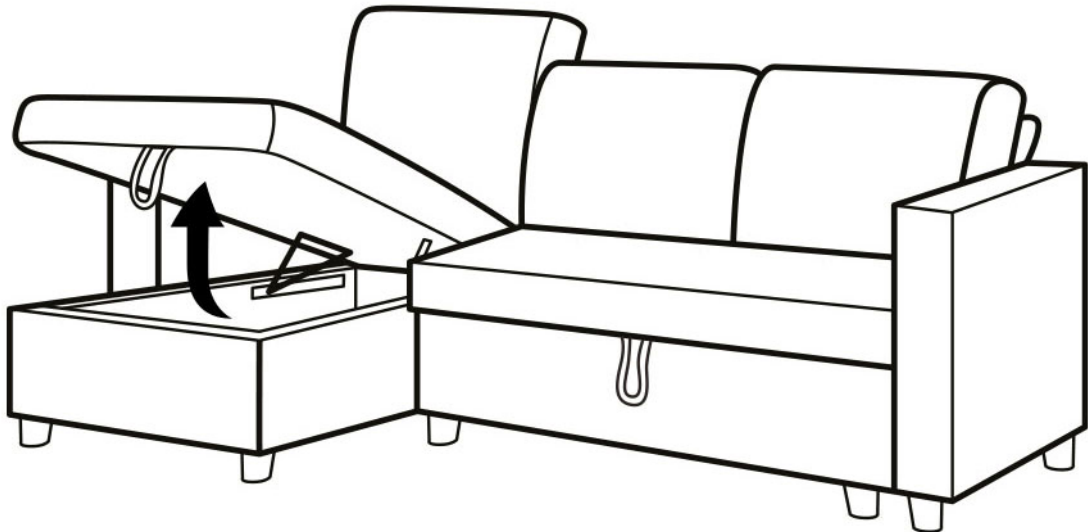

6

Para desplegar la cama, tire de la correa y levántela.

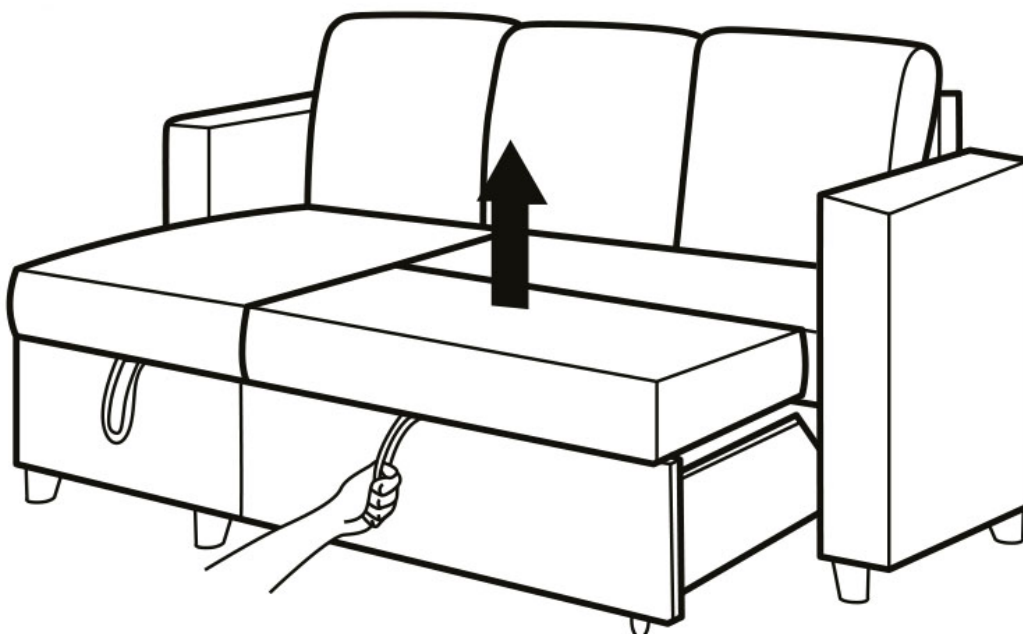

EN

If you wish to place your sofa on the **RIGHT** side of the sofa, please refer to these instructions (2 people are needed to assemble the sofa) :

1

Screw the legs onto the armrests, the sofa and the chaise longue and the castors onto the drawer in the indicated position.

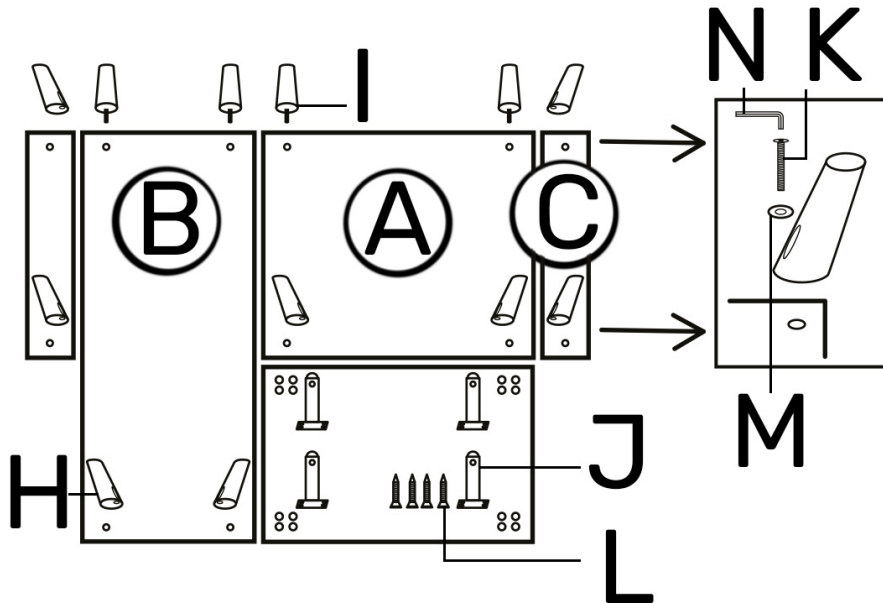

2

Attach the armrests to the sofa and the seat

- Insert the left armrest onto the sofa from top to bottom,
- Insert the right armrest onto the sofa from the bottom up.

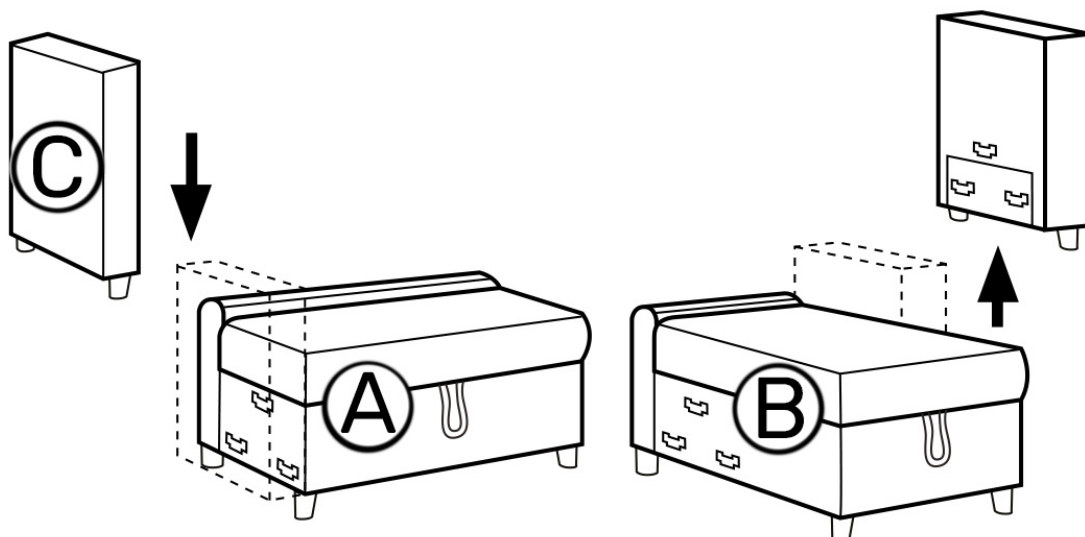

3

Attach the sofa to the seat.

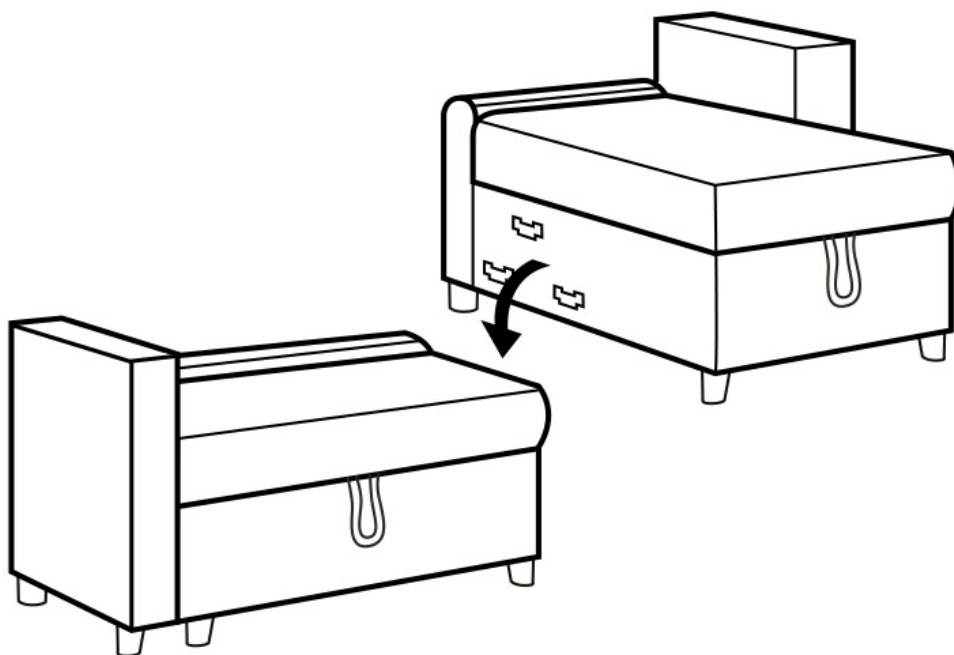

4

Slide the two backrests into the rails on the sofa and the seat.

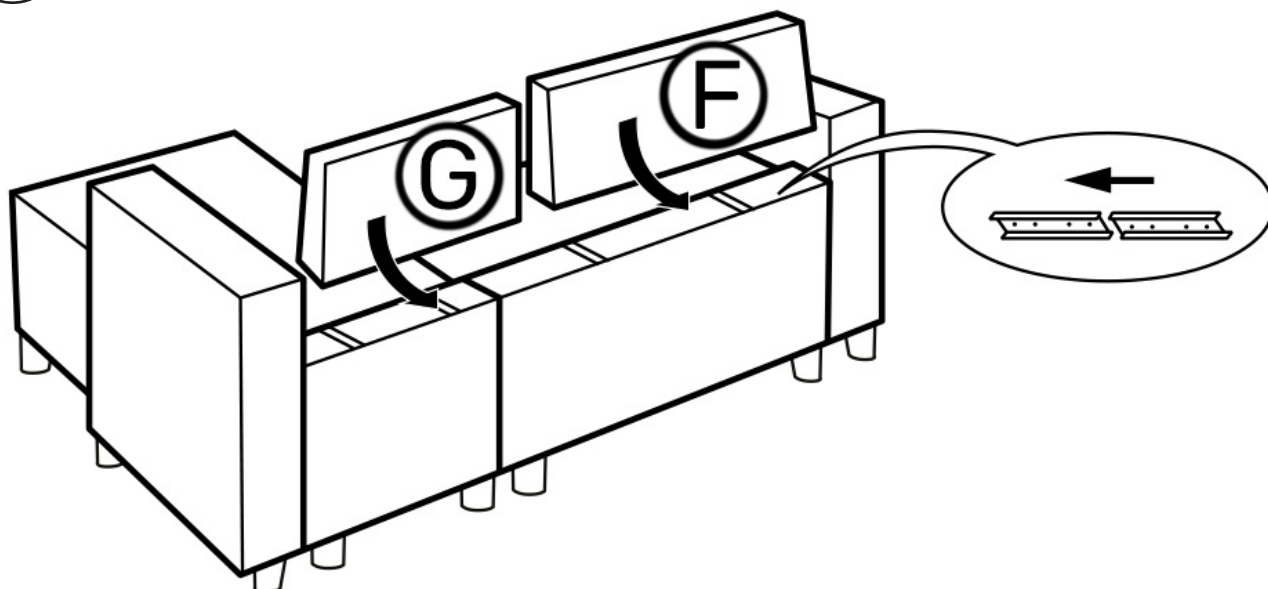

5

To access the storage box, lift the seat of the sofa.

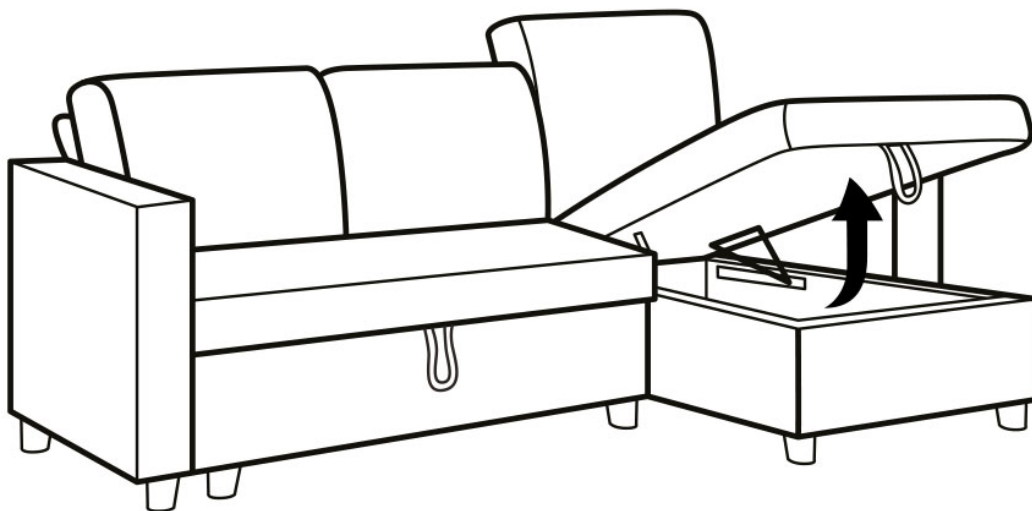

6

To unfold the bed, pull the strap and lift the bed.

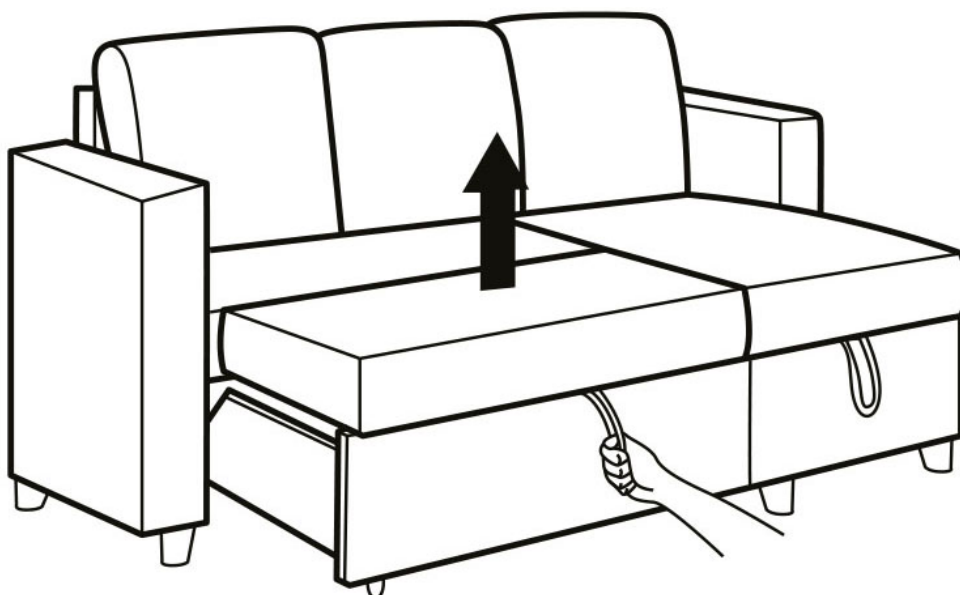

If you wish to place your sofa on the **LEFT** side of the sofa, please refer to these instructions (2 people are needed to assemble the sofa) :

1

Screw the legs onto the armrests, the sofa and the chaise longue and the castors onto the drawer in the indicated position.

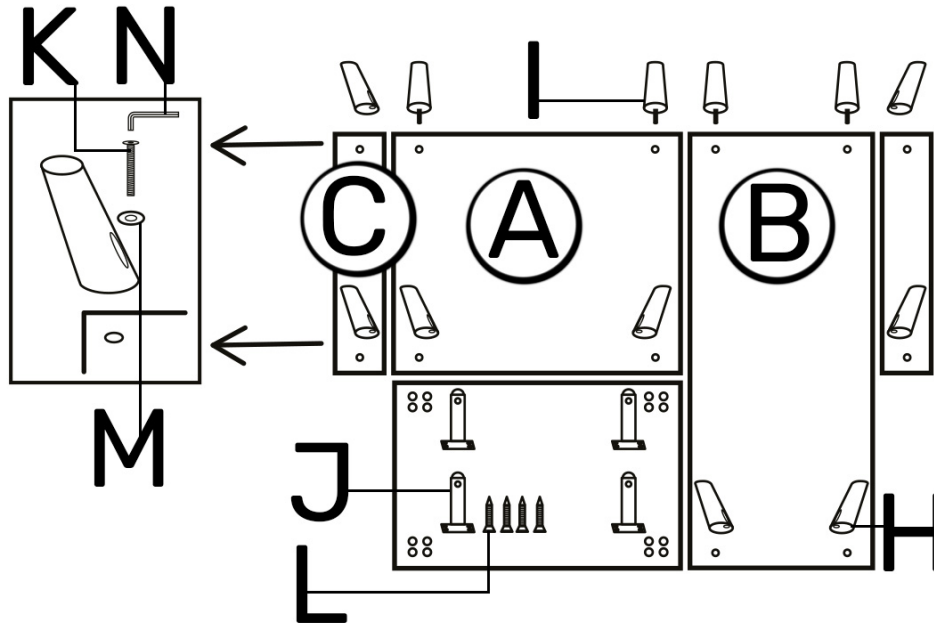

2

Attach the armrests to the sofa and the chaise longue
 - Insert the left armrest on the sofa from top to bottom,
 - Insert the right armrest onto the sofa from the bottom up.

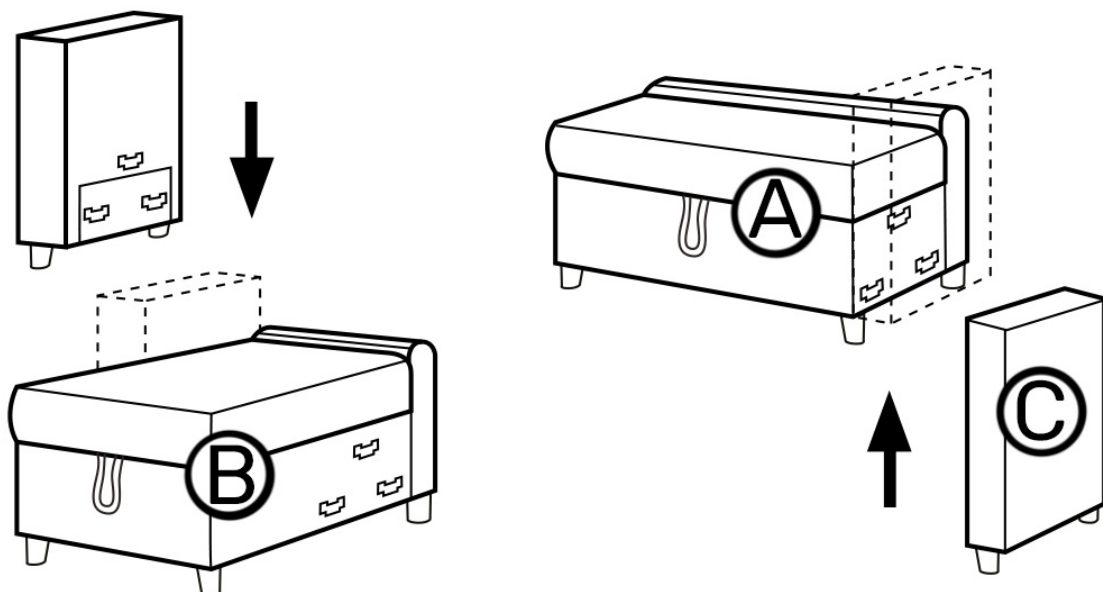

3

Attach the sofa to the seat.

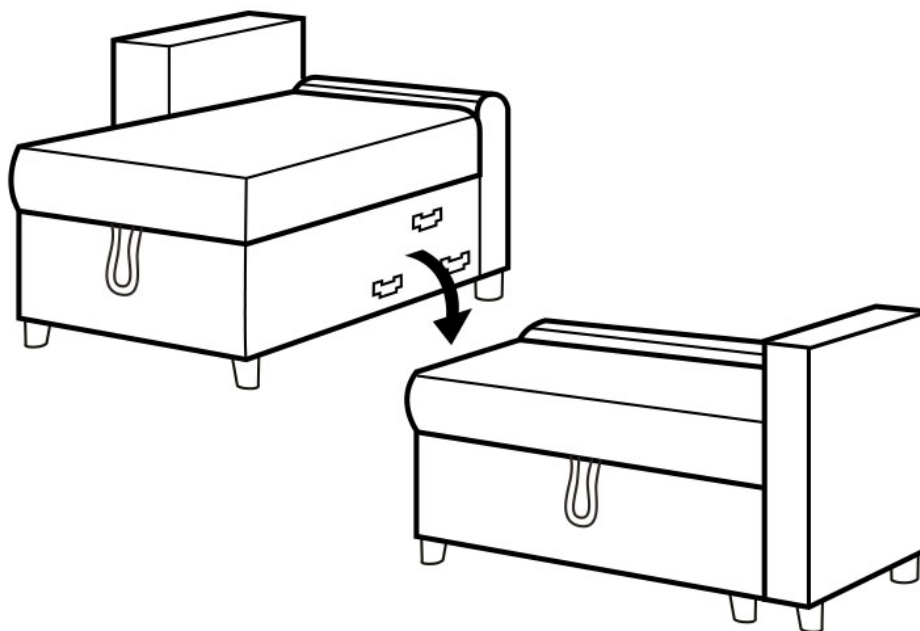

4

Slide the two backrests into the rails on the sofa and the seat.

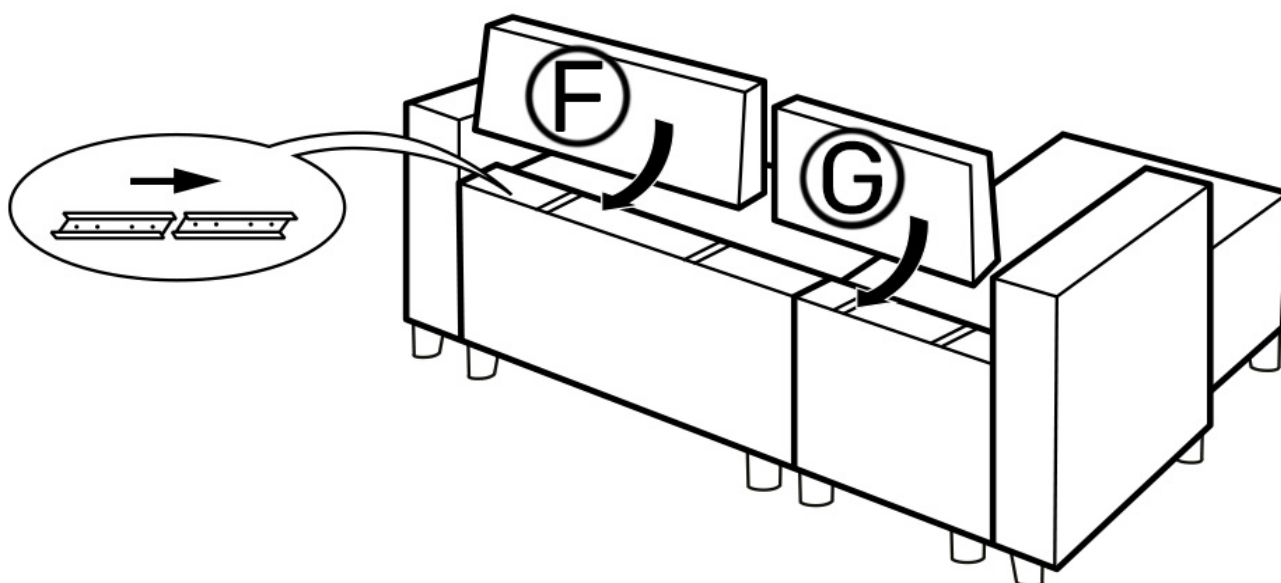

5

To access the storage box, lift the seat of the sofa.

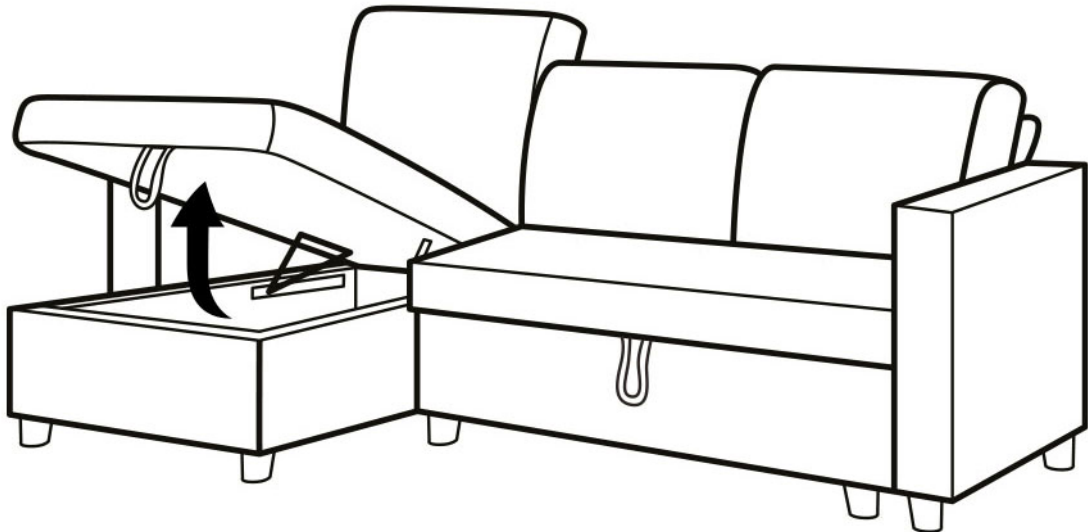

6

To unfold the bed, pull the strap and lift the bed.

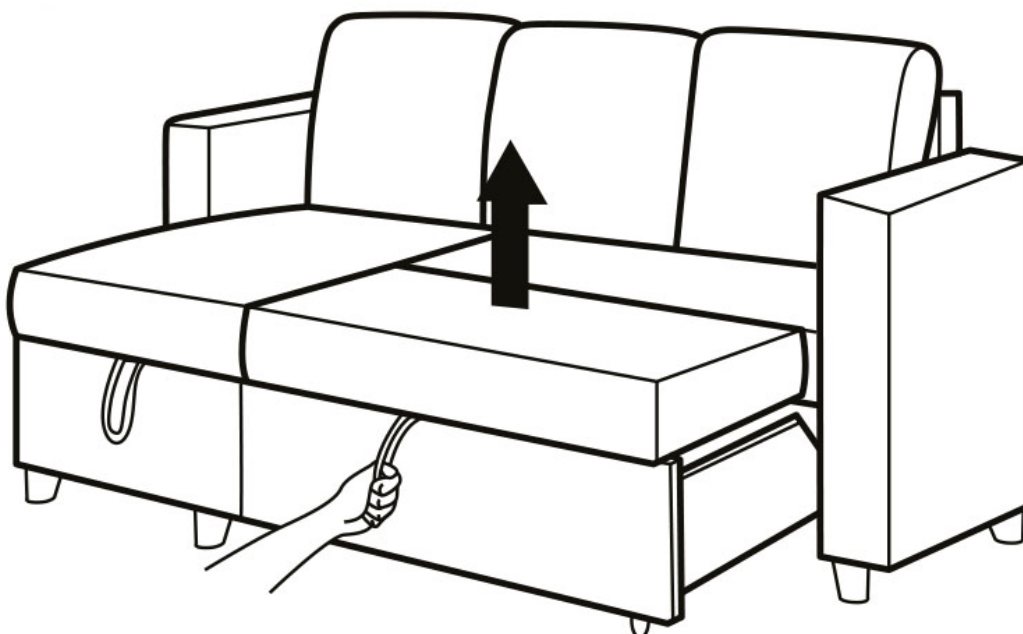

DE

Wenn Sie Ihren Loungetisch auf der **RECHTEN** Seite des Sofas platzieren möchten, beachten Sie bitte diese Anleitung (für den Aufbau des Sofas sind 2 Personen erforderlich):

1

Schrauben Sie die FüÙe an die Armlehnen, das Sofa und den Longchair sowie die Rollen an die Schublade an der angegebenen Stelle.

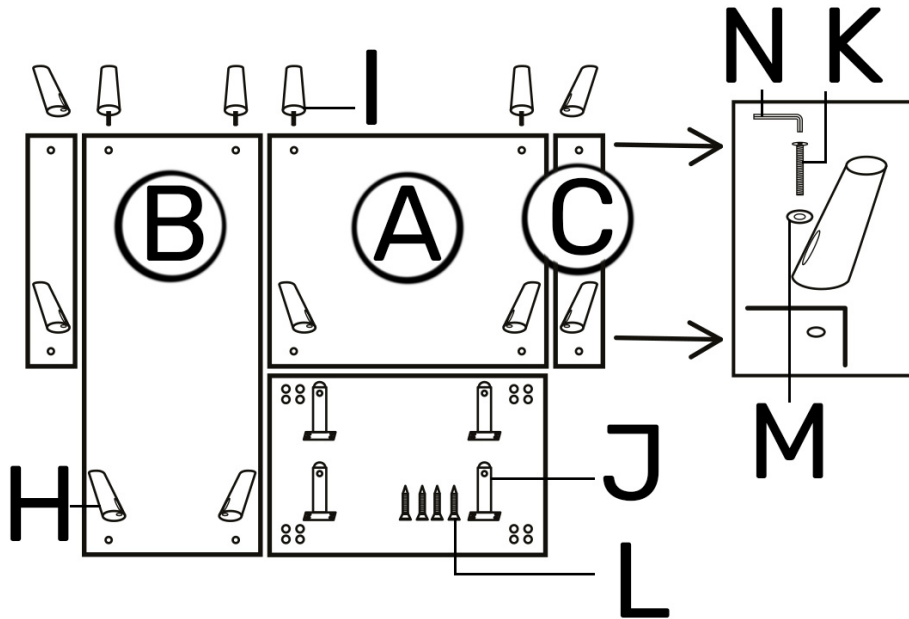

2

Befestigen Sie die Armlehnen mit dem Sofa und dem Longchair.

- Stecken Sie die linke Armlehne von oben nach unten auf das Sofa,
- Stecken Sie die rechte Armlehne von unten nach oben in das Sofa.

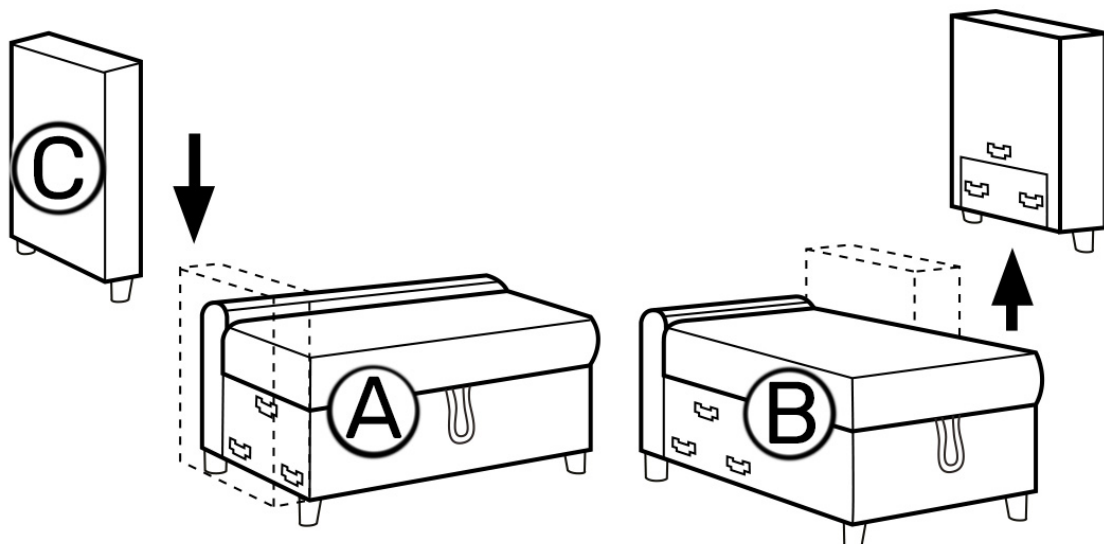

3

Befestigen Sie das Sofa mit dem Armlehenträger.

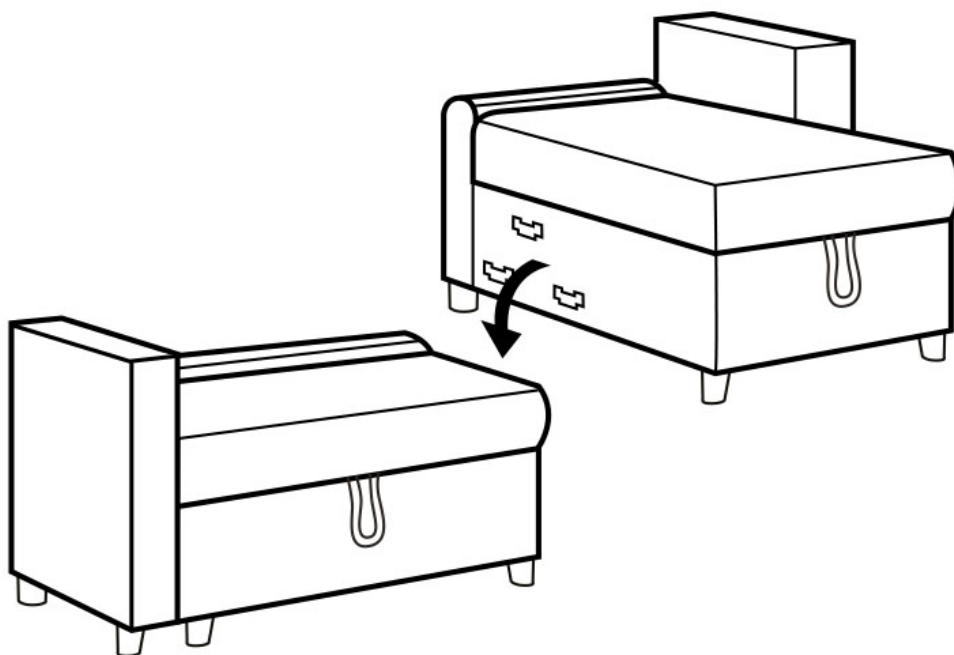

4

Schieben Sie die beiden Rückenlehnen in die Schienen des Sofas und des Armlehenträgers.

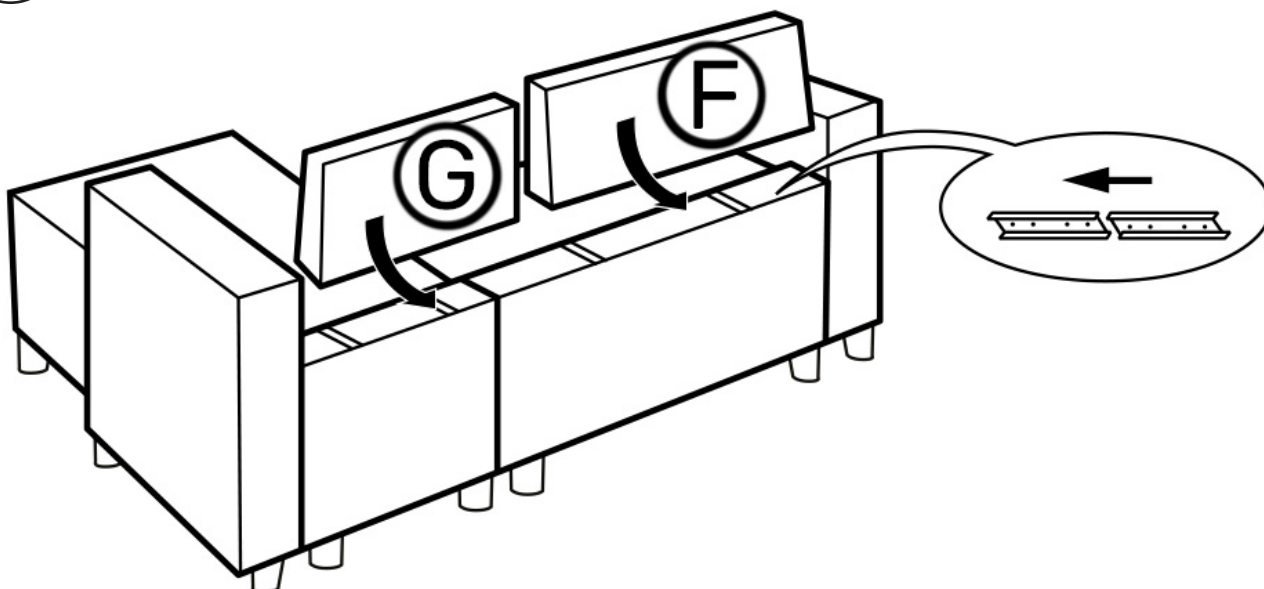

5

Um an den Stauraum zu gelangen, heben Sie die Sitzfläche der Liege an.

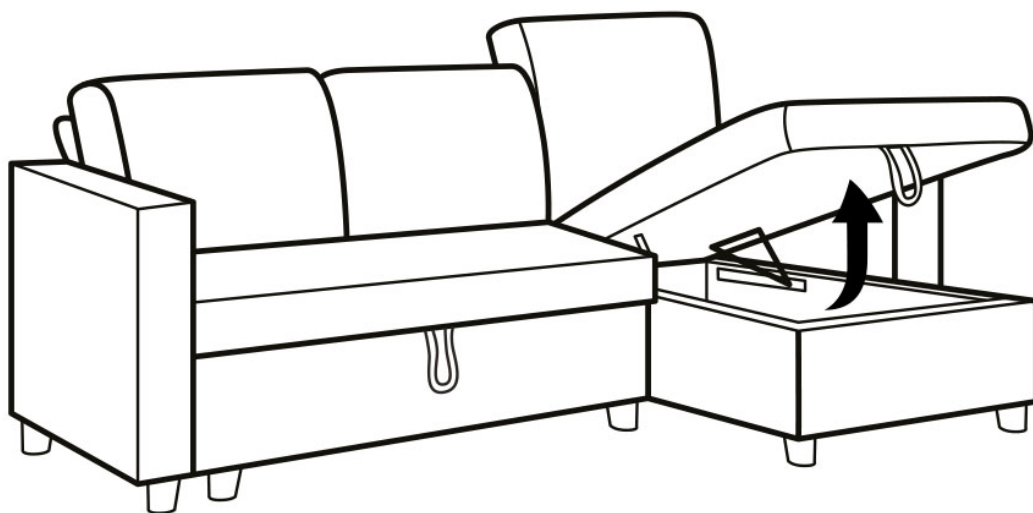

6

Um das Bett auszuklappen, ziehen Sie am Riemen und heben Sie die Liegefläche an.

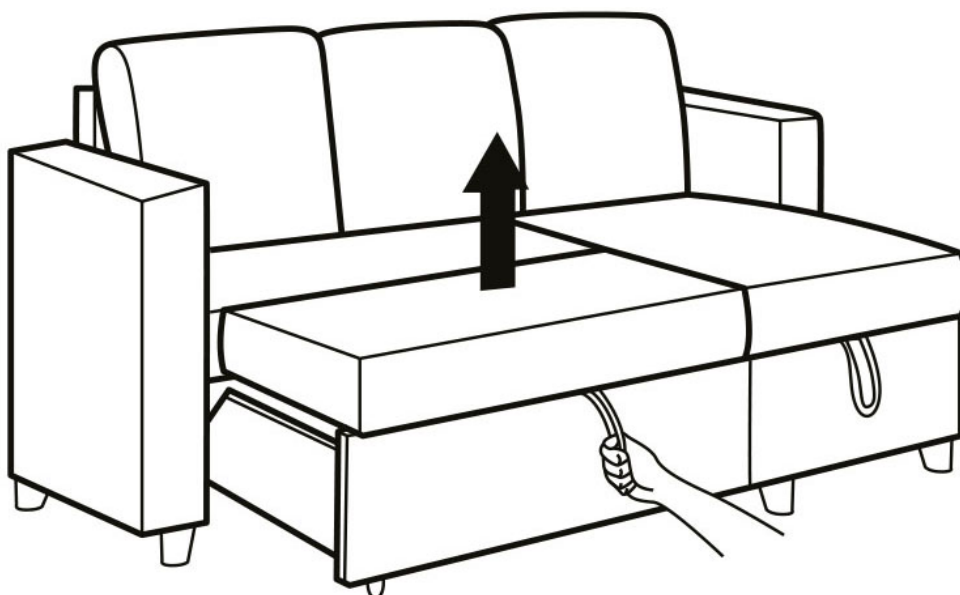

Wenn Sie Ihren Loungetisch auf der **LINKEN** Seite des Sofas platzieren möchten, beachten Sie bitte diese Anleitung (für den Aufbau des Sofas sind 2 Personen erforderlich) :

1

Schrauben Sie die Füße an die Armlehnen, das Sofa und den Longchair sowie die Rollen an die Schublade an der angegebenen Stelle.

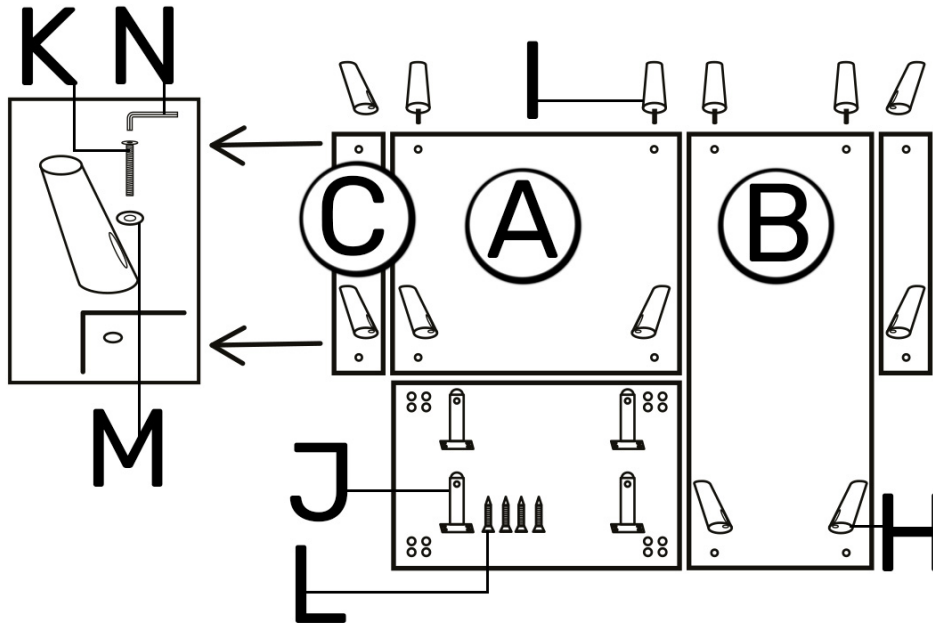

2

Befestigen Sie die Armlehnen mit dem Sofa und dem Longchair.
 - Stecken Sie die linke Armlehne von oben nach unten auf den Longchair,
 - Stecken Sie die rechte Armlehne von unten nach oben auf das Sofa.

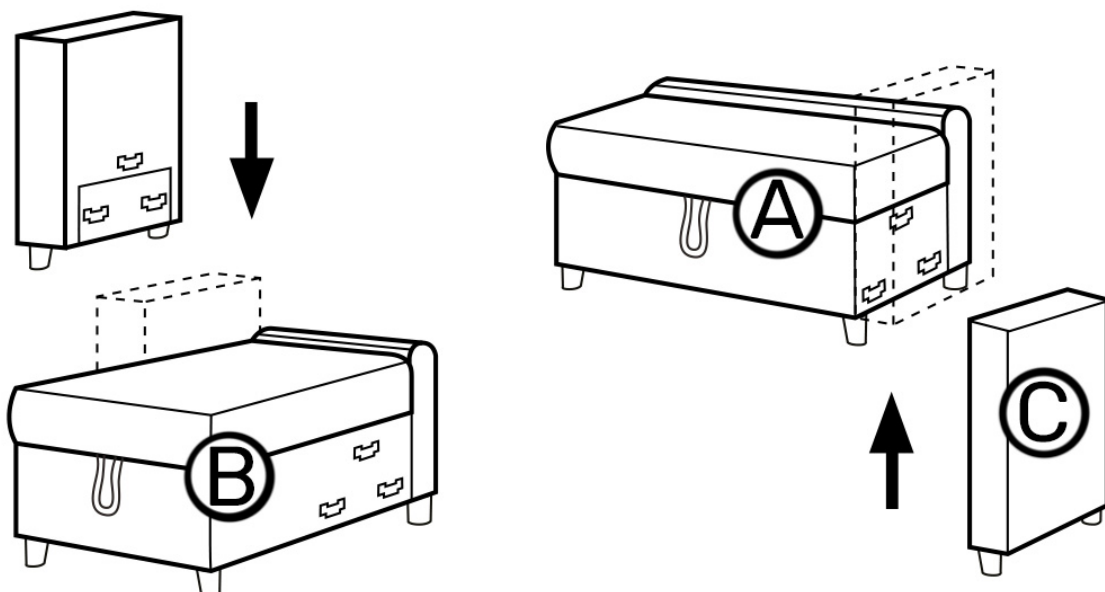

3

Befestigen Sie das Sofa mit dem Armlehenträger.

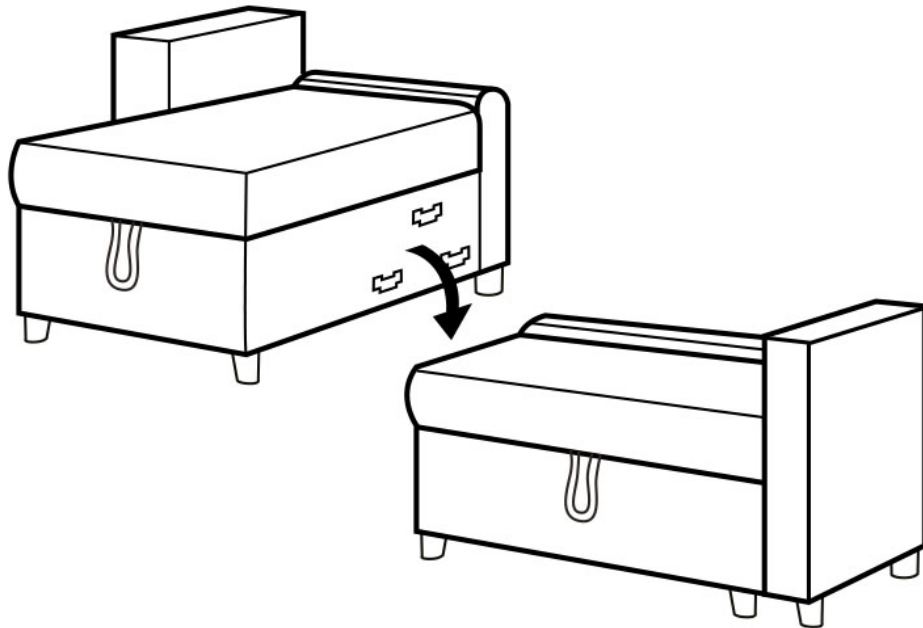

4

Schieben Sie die beiden Rückenlehnen in die Schienen des Sofas und des Armlehenträgers.

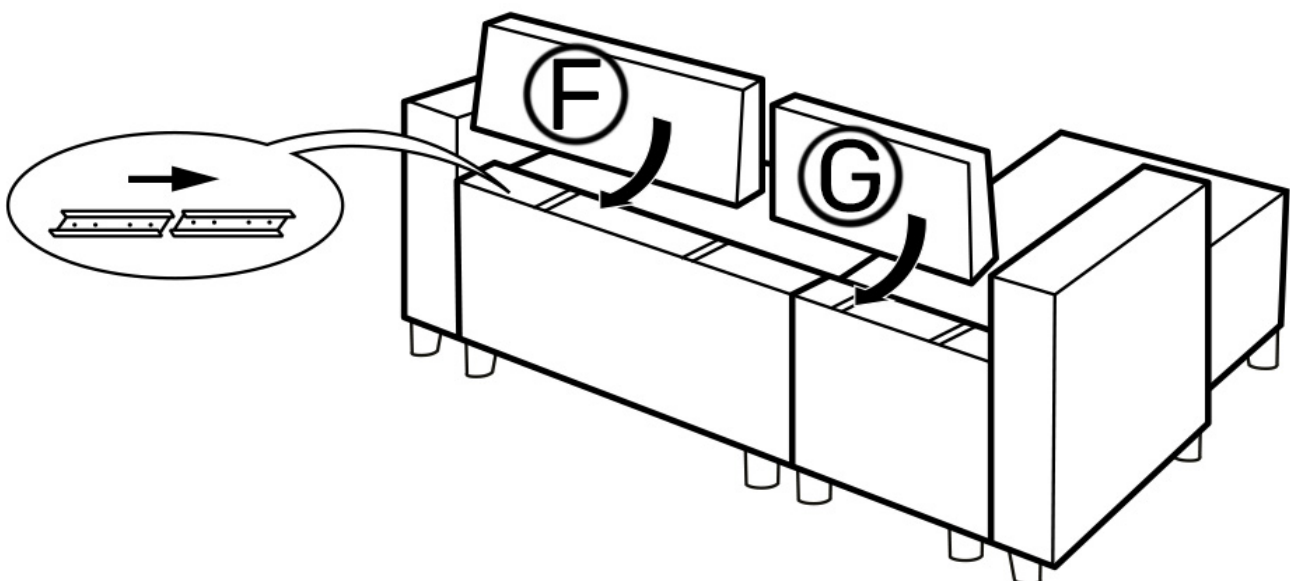

5

Um an den Stauraum zu gelangen, heben Sie die Sitzfläche der Liege an.

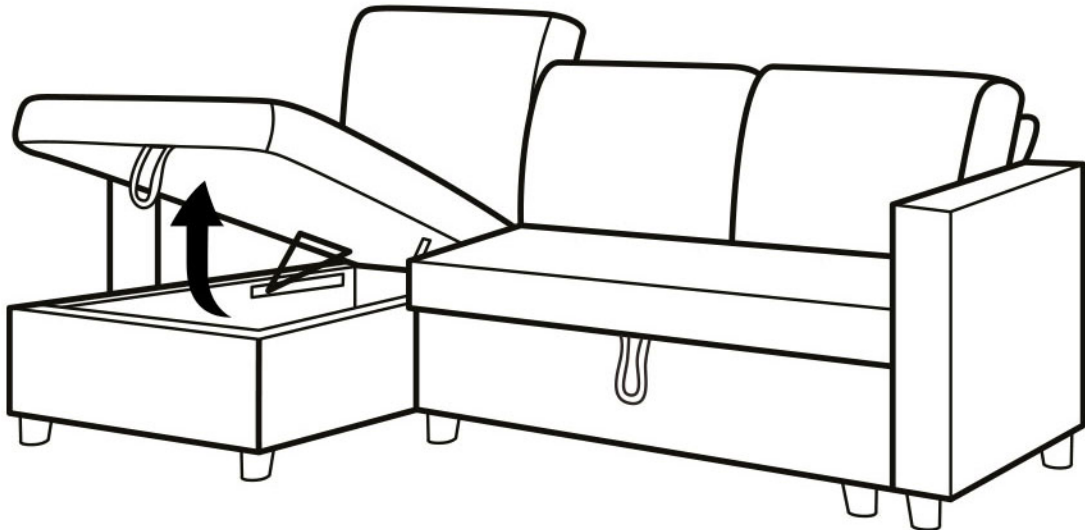

6

Um das Bett auszuklappen, ziehen Sie am Riemen und heben Sie die Liegefläche an.

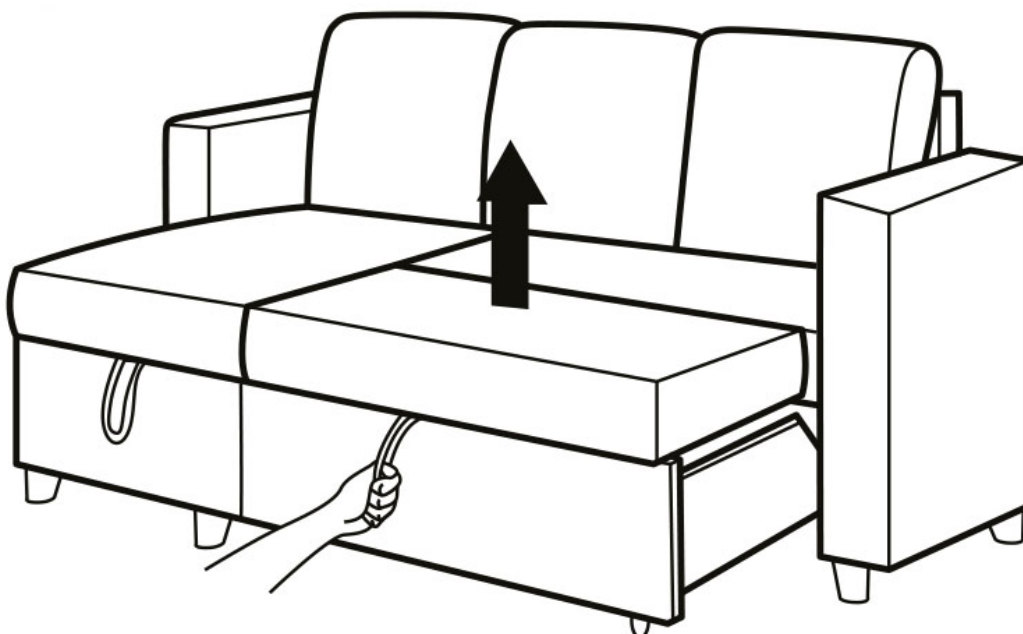

NL

Raadpleeg deze instructies als u de bank aan de **RECHTER** kant wilt plaatsen (er zijn 2 personen nodig om de bank in elkaar te zetten):

1

Schroef de poten op de armleuningen, de bank en de chaise longue en de wielen op de lade in de aangegeven positie.

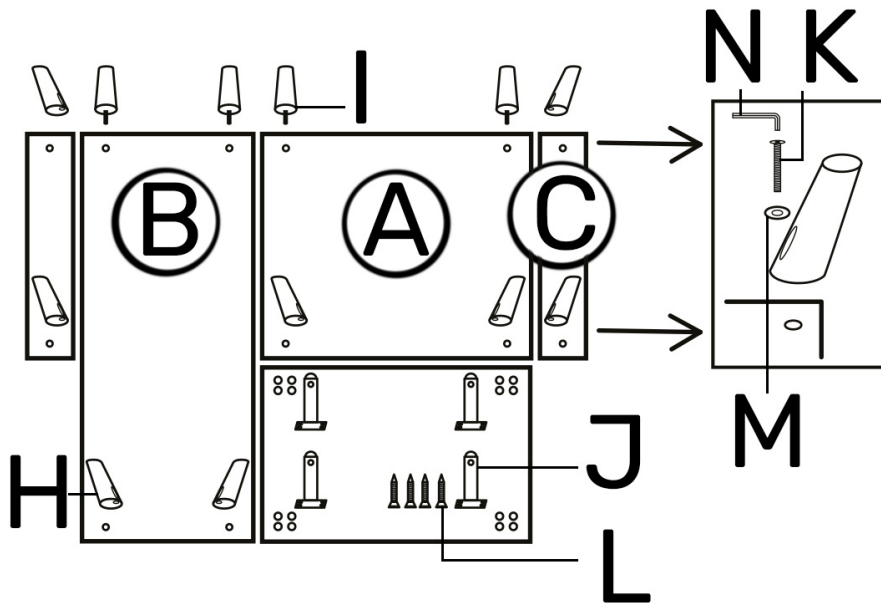

2

Bevestig de armleuningen aan de bank en de zitting

- Plaats de linker armleuning van boven naar beneden op de bank,
- Plaats de rechter armleuning van onder naar boven op de bank.

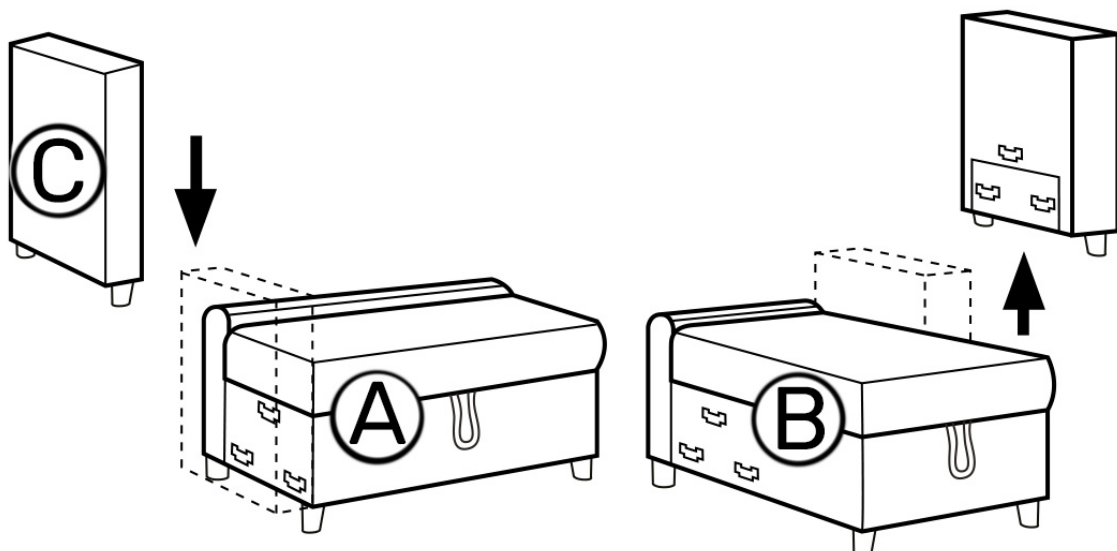

3

Bevestig de bank aan de zitting.

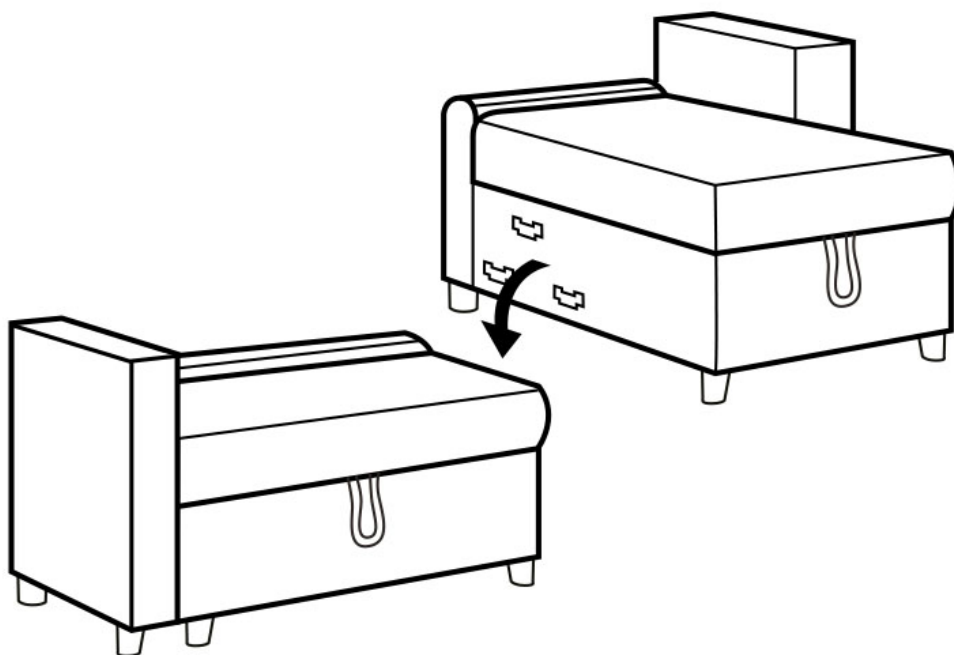

4

Schuif de twee rugleuningen in de rails van de bank en de zitting.

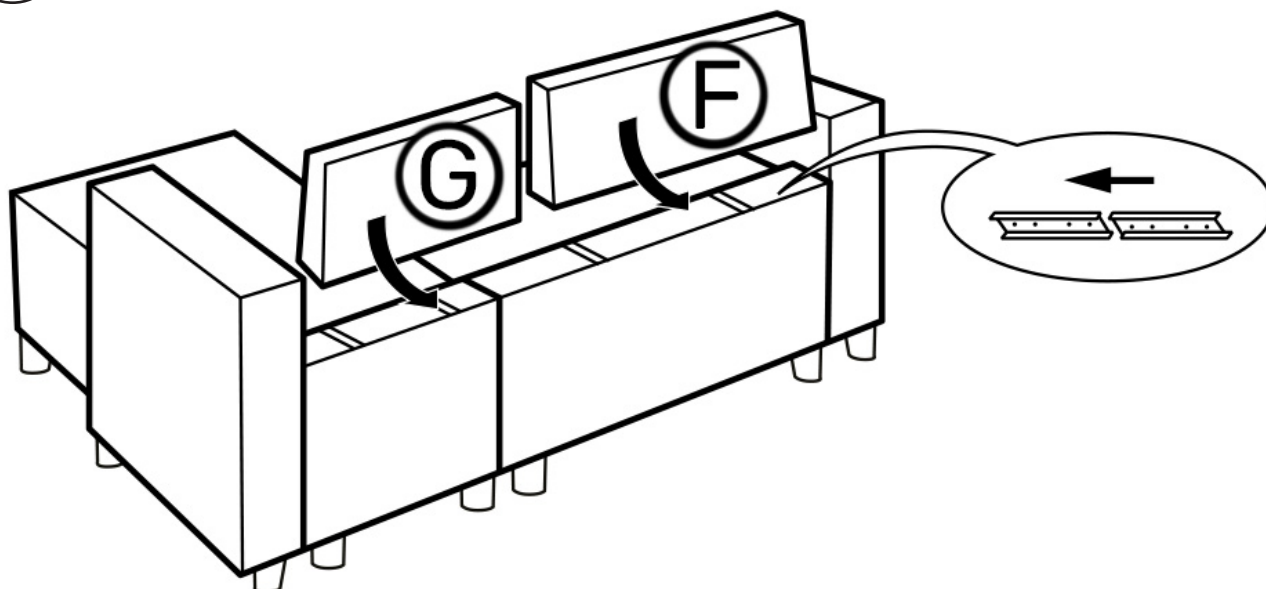

5

Om bij het opbergvak te komen, tilt u de zitting van de bank op.

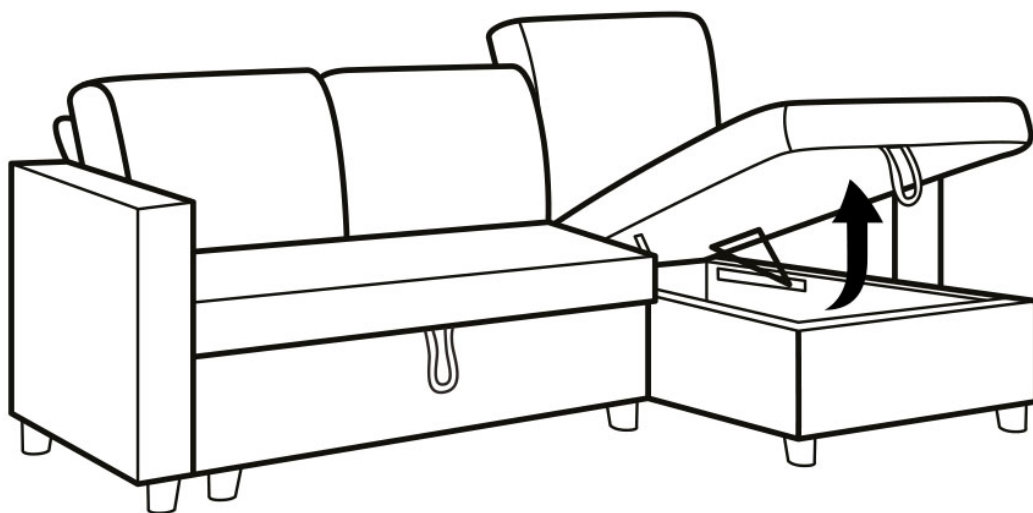

6

Om het bed uit te klappen, trekt u aan de riem en tilt u het bed op.

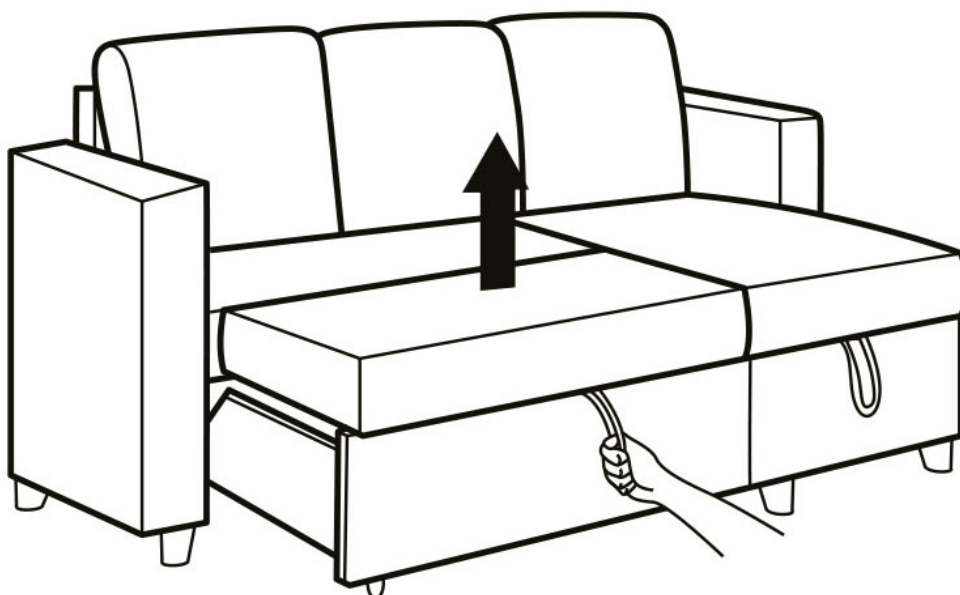

Als u uw bank aan de **LINKERKANT** wilt plaatsen, raadpleeg dan deze instructies (er zijn 2 personen nodig om de bank in elkaar te zetten) :

1

Schroef de poten op de armleuningen, de bank en de chaise longue en de wielen op de lade in de aangegeven positie.

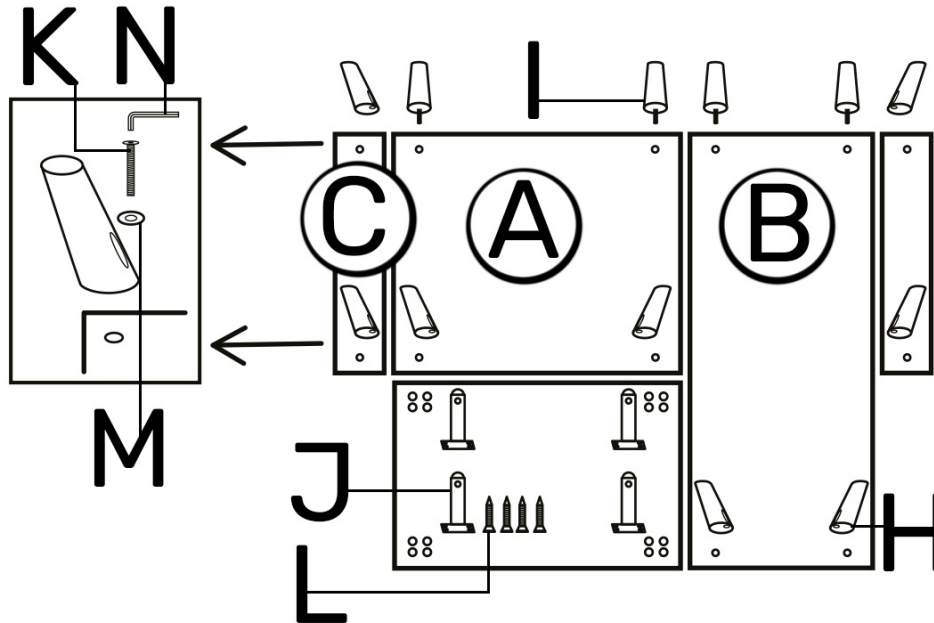

2

Bevestig de armleuningen aan de bank en de chaise longue
 - Plaats de linker armleuning van boven naar beneden op de bank,
 - Plaats de rechter armleuning van onder naar boven op de bank.

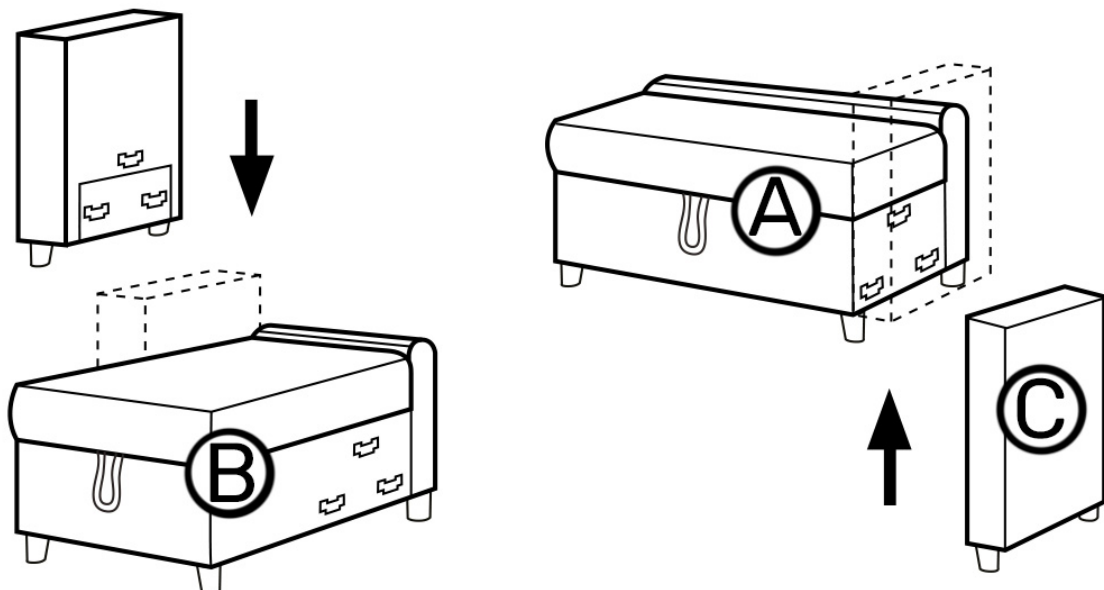

3

Bevestig de bank aan de zitting.

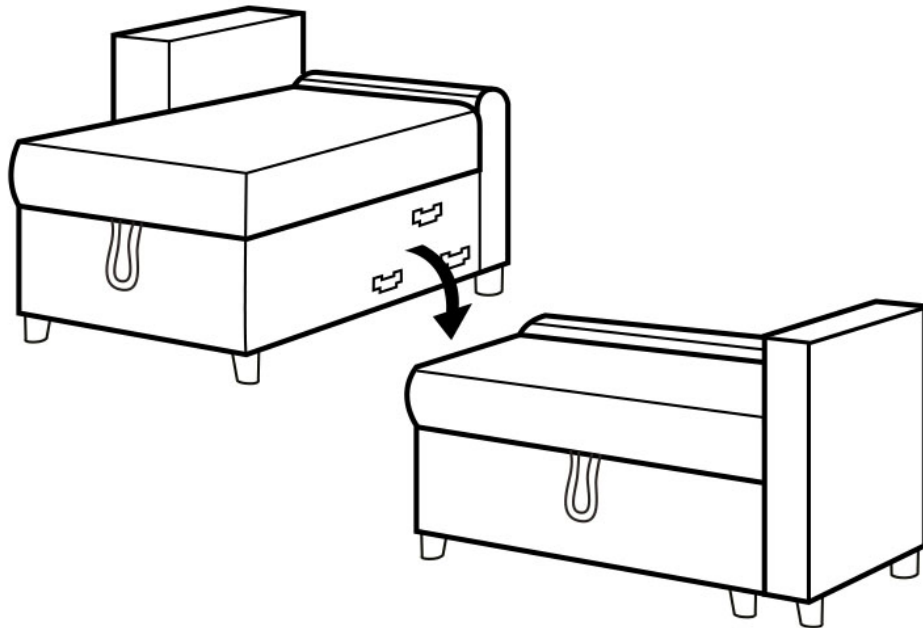

4

Schuif de twee rugleuningen in de rails van de bank en de zitting.

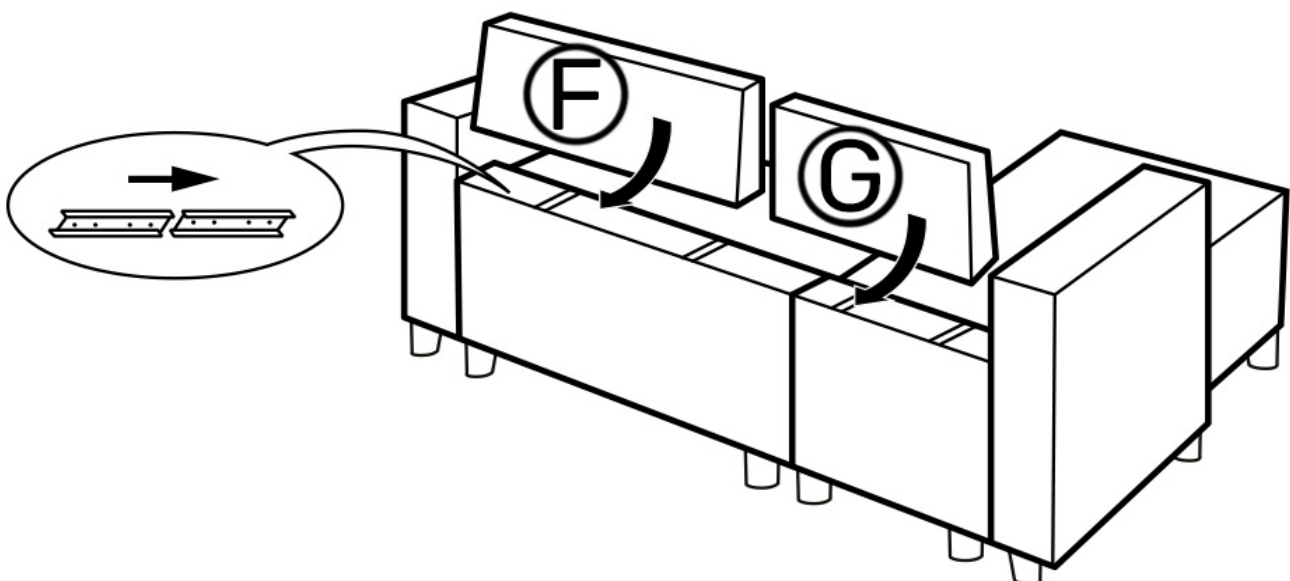

5

Om bij het opbergvak te komen, tilt u de zitting van de bank op.

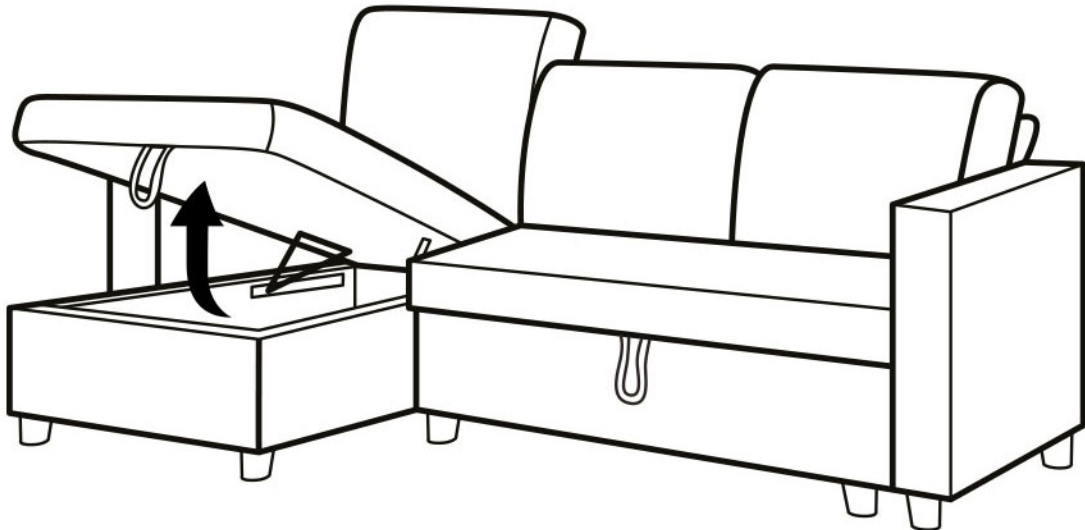

6

Om het bed uit te klappen, trekt u aan de riem en tilt u het bed op.

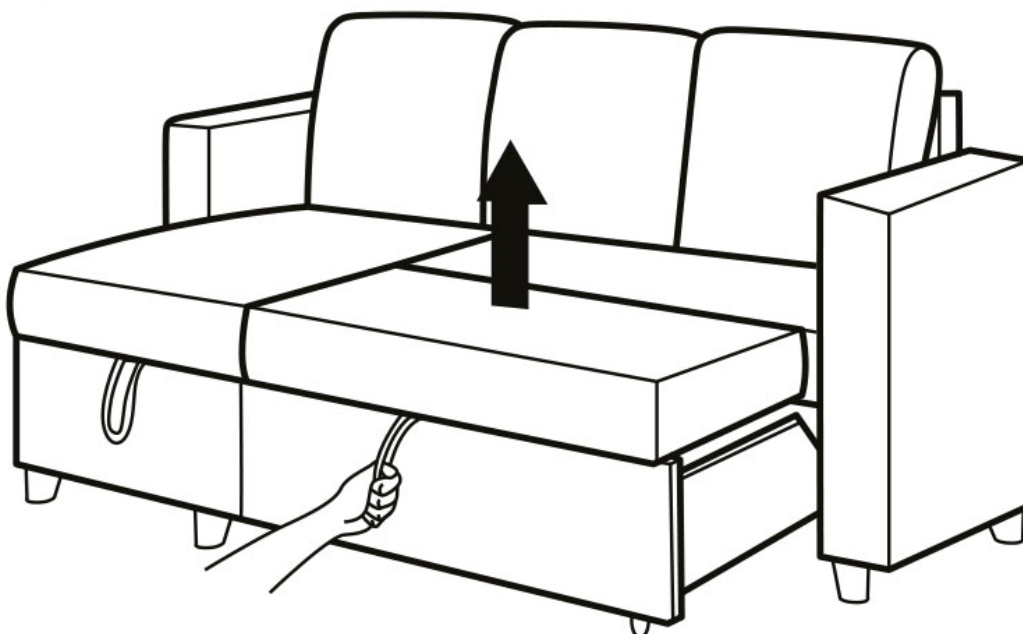

IT

Se desidera posizionare il divano sul lato **DESTRO** del divano, faccia riferimento a queste istruzioni (sono necessarie 2 persone per assemblare il divano):

1

Avviti le gambe ai braccioli, al divano e alla chaise longue e le rotelle al cassetto nella posizione indicata.

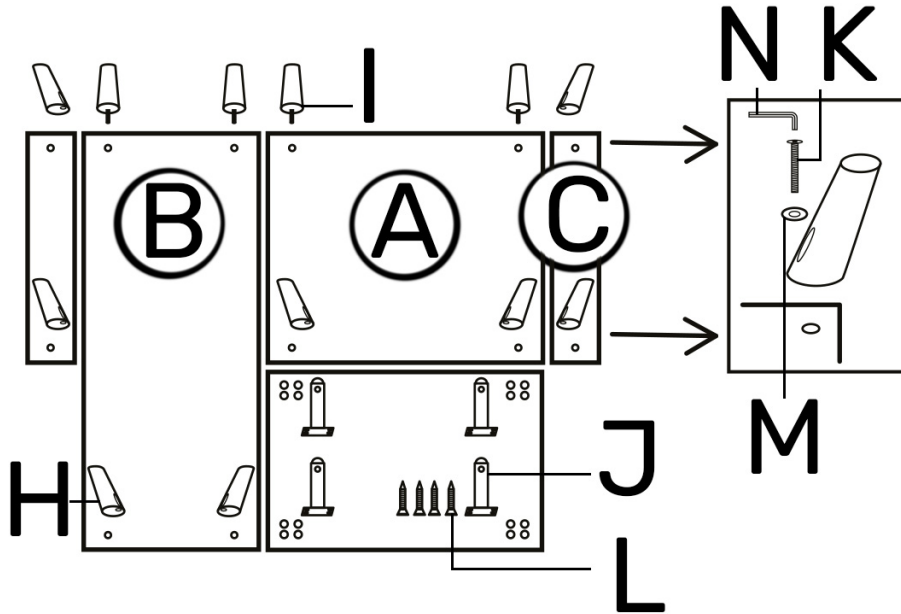

2

Fissi i braccioli al divano e alla seduta.

- Inserisca il bracciolo sinistro sul divano dall'alto verso il basso,
- Inserisca il bracciolo destro sul divano dal basso verso l'alto.

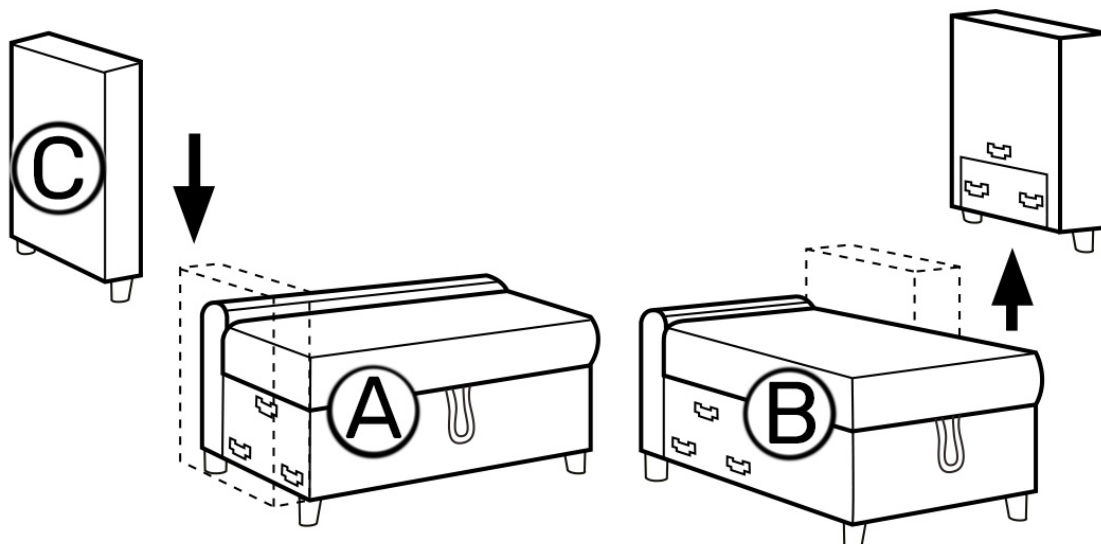

3

Fissi il divano alla seduta.

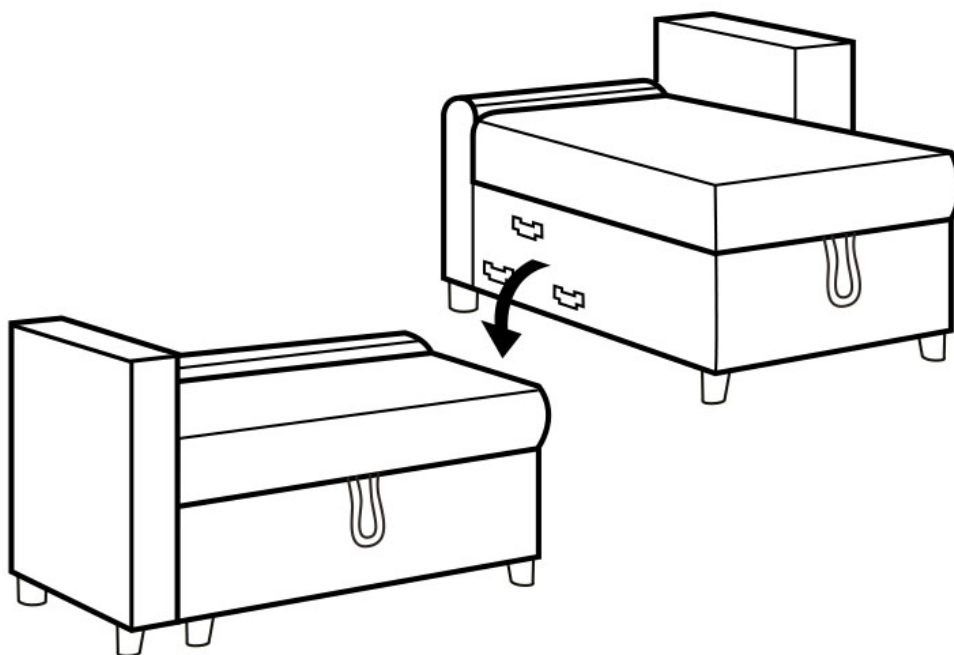

4

Faccia scorrere i due schienali nelle guide del divano e della seduta.

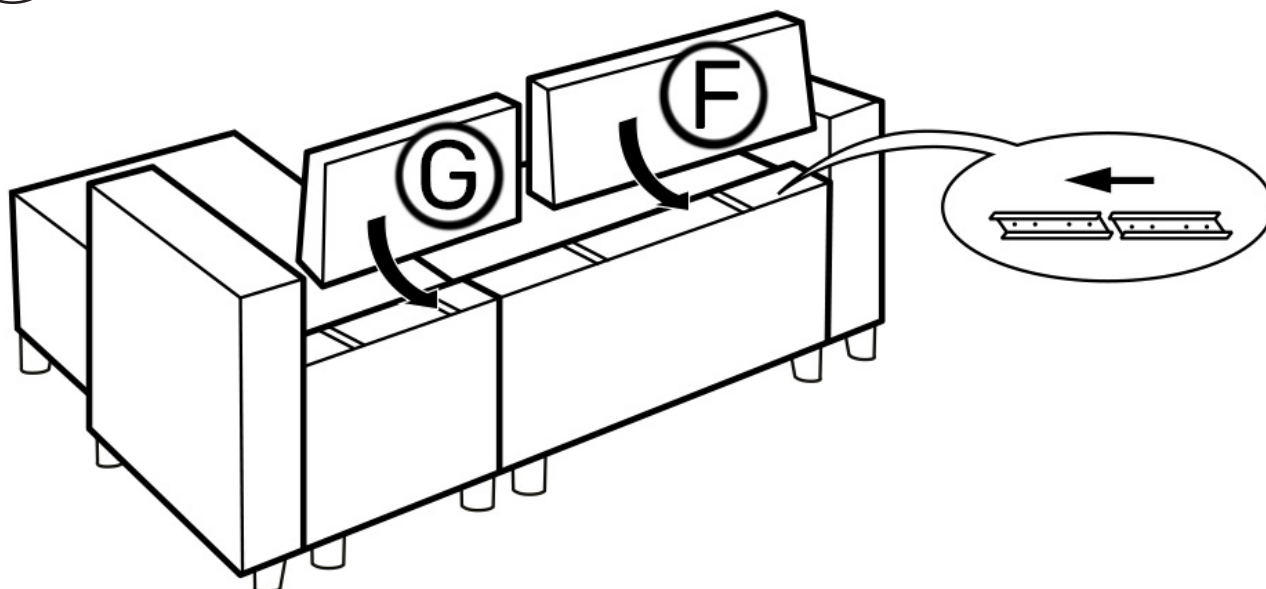

5

Per accedere al box portaoggetti, sollevi la seduta del divano.

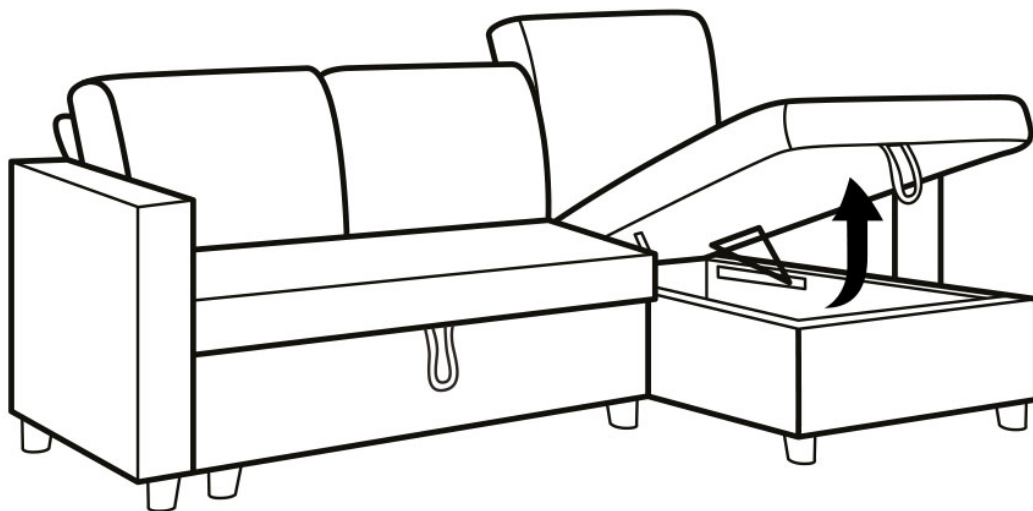

6

Per aprire il letto, tirare la cinghia e sollevare il letto.

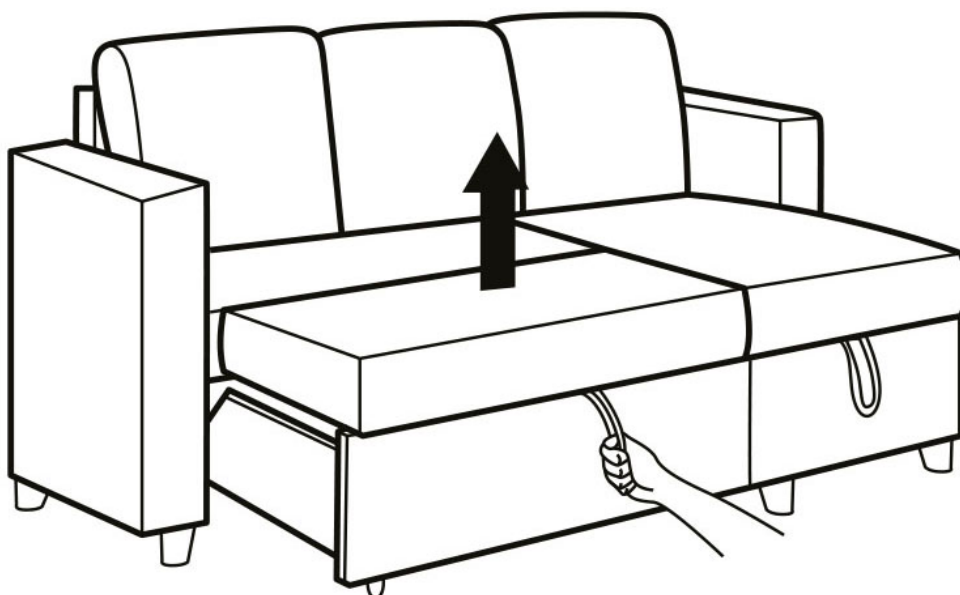

Se desidera posizionare il divano sul lato **SINISTRO**, faccia riferimento a queste istruzioni (sono necessarie 2 persone per assemblare il divano) :

1

Avviti le gambe ai braccioli, al divano e alla chaise longue e le rotelle al cassetto nella posizione indicata.

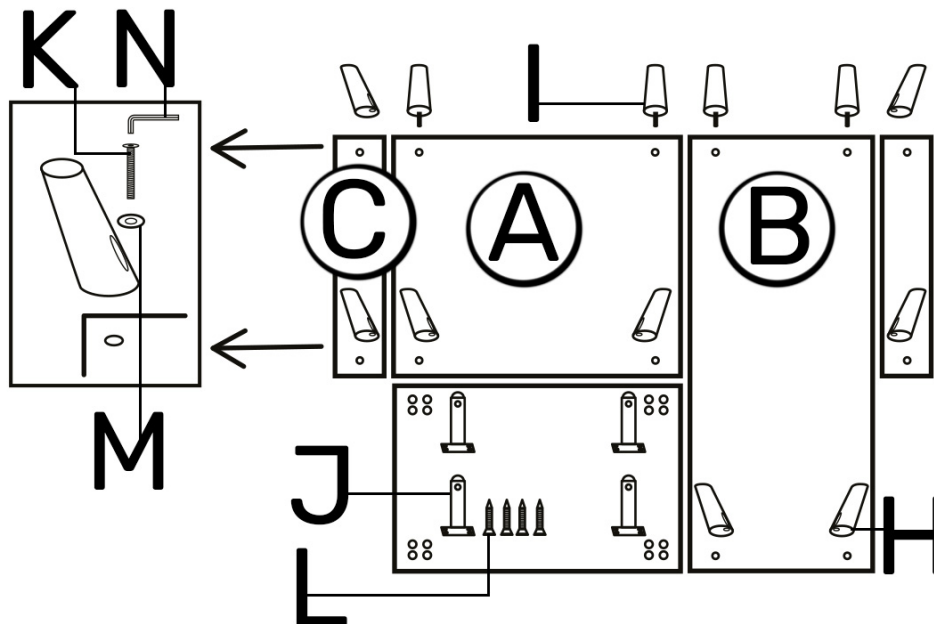

2

Fissi i braccioli al divano e alla chaise longue.

- Inserisca il bracciolo sinistro sul divano dall'alto verso il basso,
- Inserisca il bracciolo destro sul divano dal basso verso l'alto.

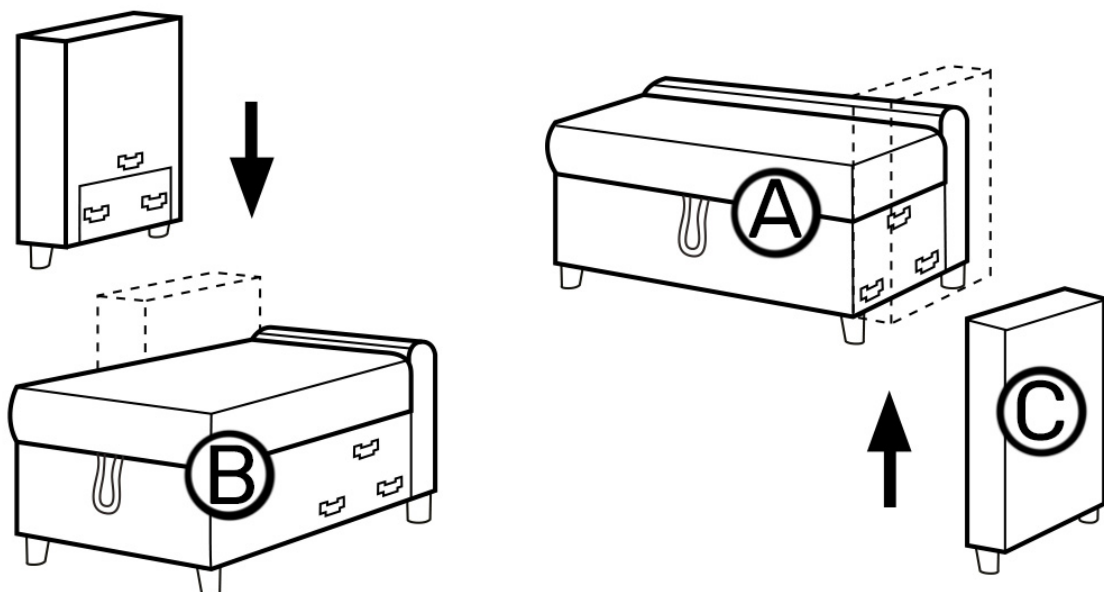

3

Fissi il divano alla seduta.

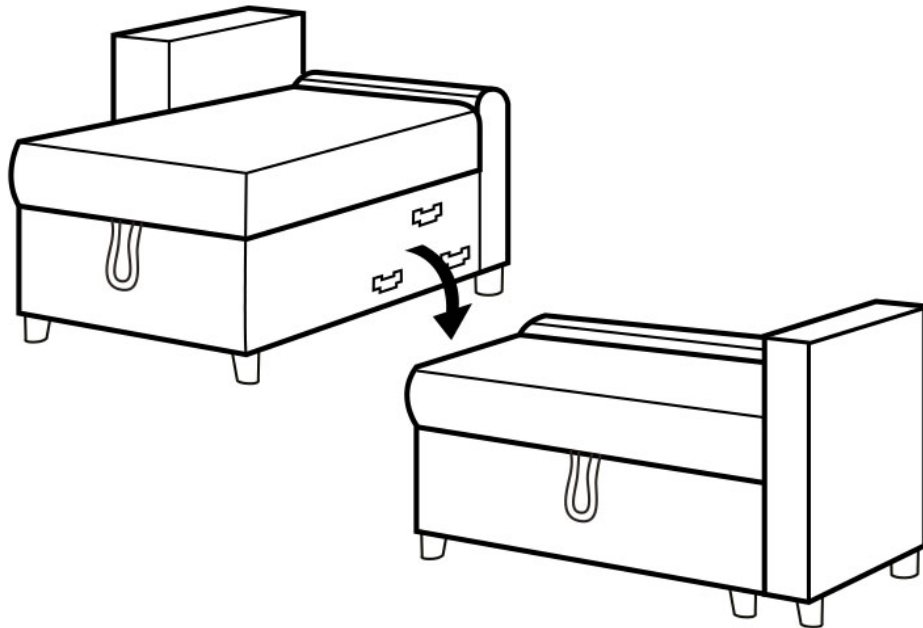

4

Faccia scorrere i due schienali nelle guide del divano e della seduta.

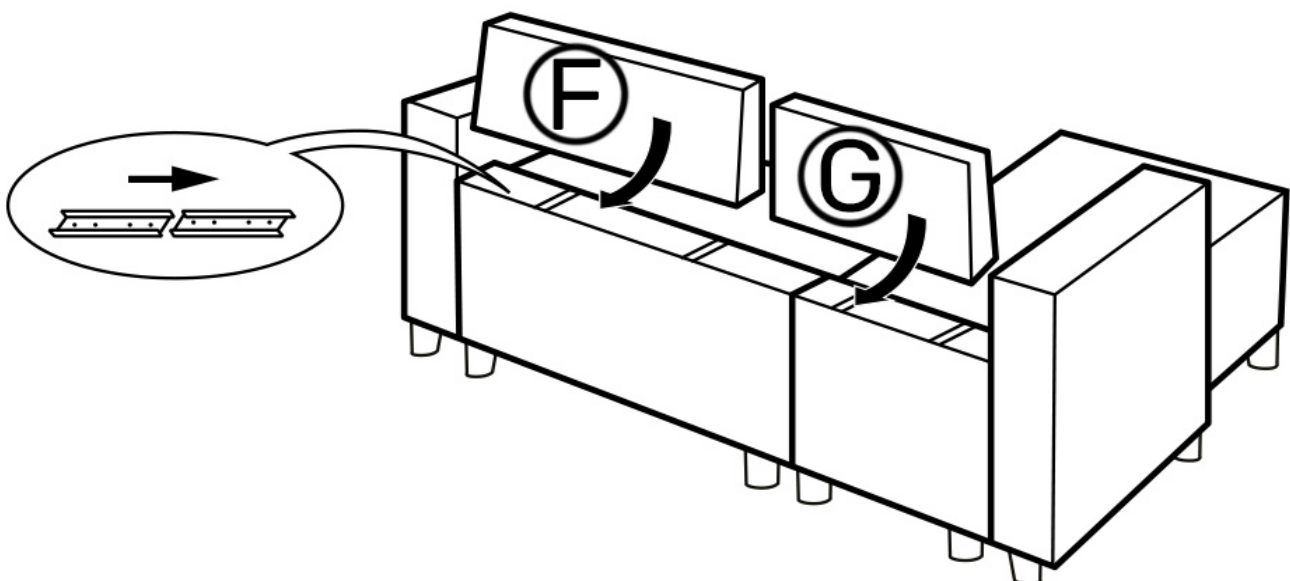

5

Per accedere al box portaoggetti, sollevi la seduta del divano.

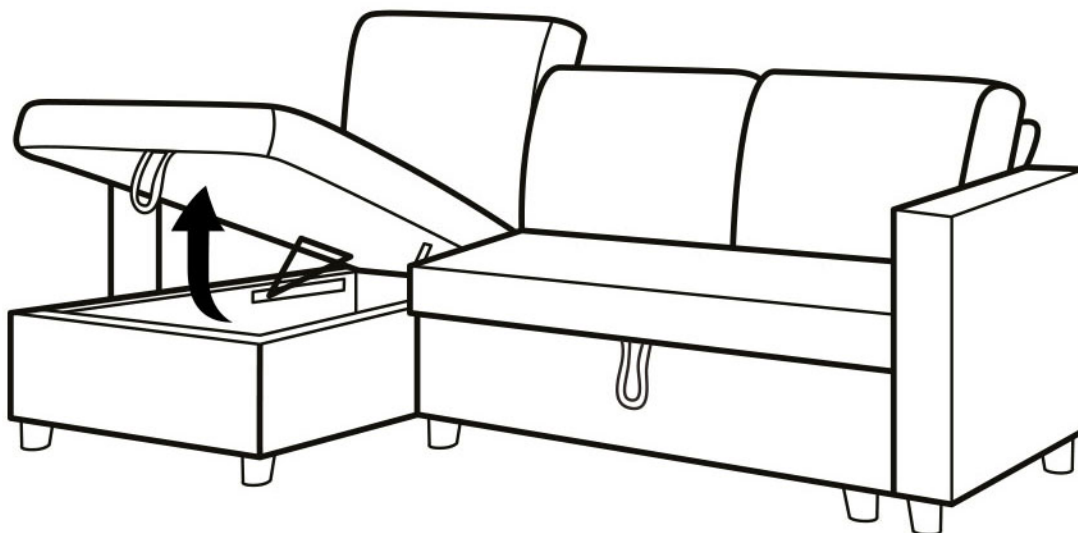

6

Per aprire il letto, tirare la cinghia e sollevare il letto.

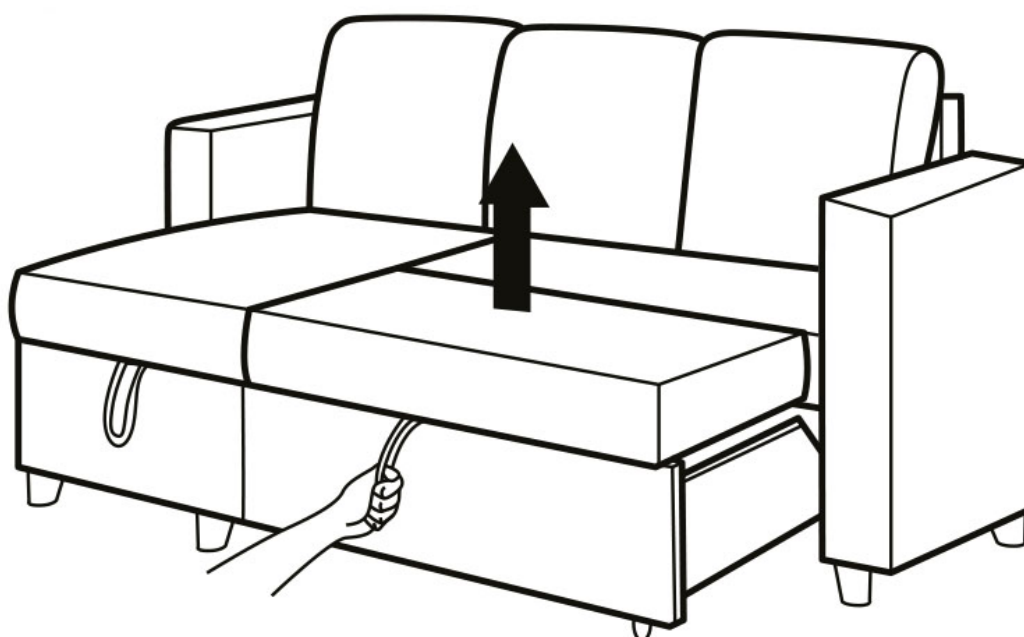

PT

Se desejar colocar o seu sofá no lado **DIREITO** do sofá, consulte estas instruções (são necessárias 2 pessoas para montar o sofá):

1

Enrosque as pernas nos apoios dos braços, o sofá e a chaise-longue e as rodas na gaveta na posição indicada.

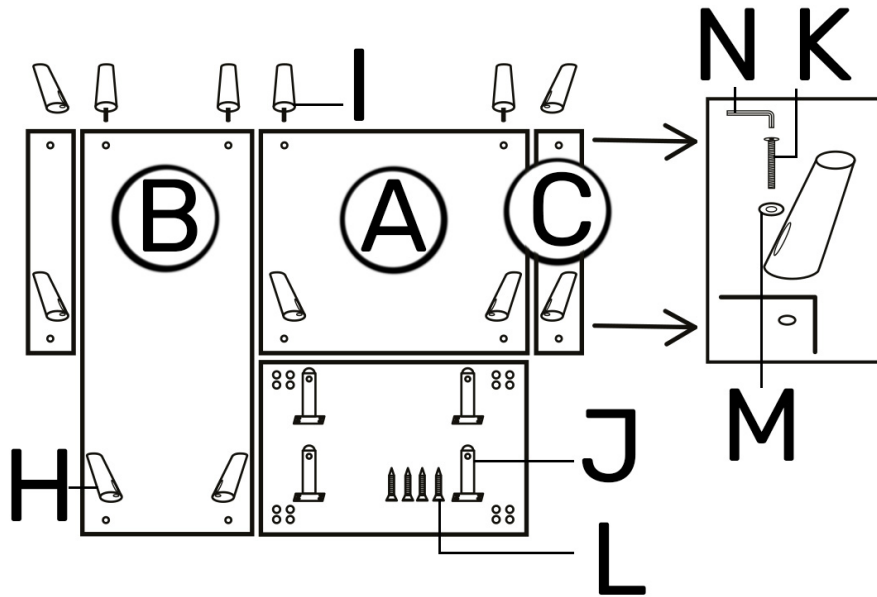

2

Fixe os apoios de braços ao sofá e ao assento

- Insira o apoio de braço esquerdo no sofá de cima para baixo,
- Insira o apoio de braço direito no sofá, de baixo para cima.

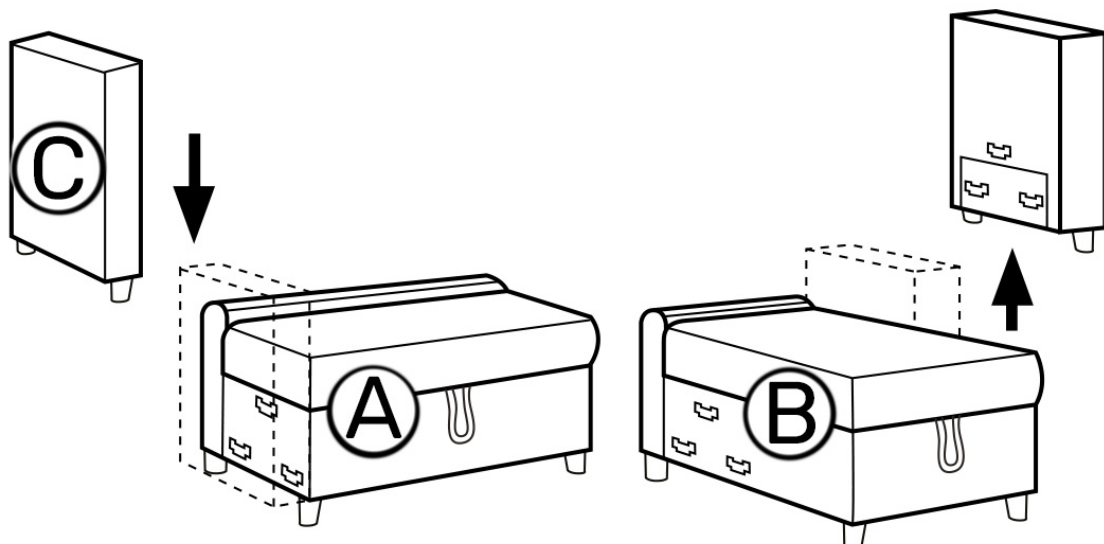

3

Prenda o sofá ao assento.

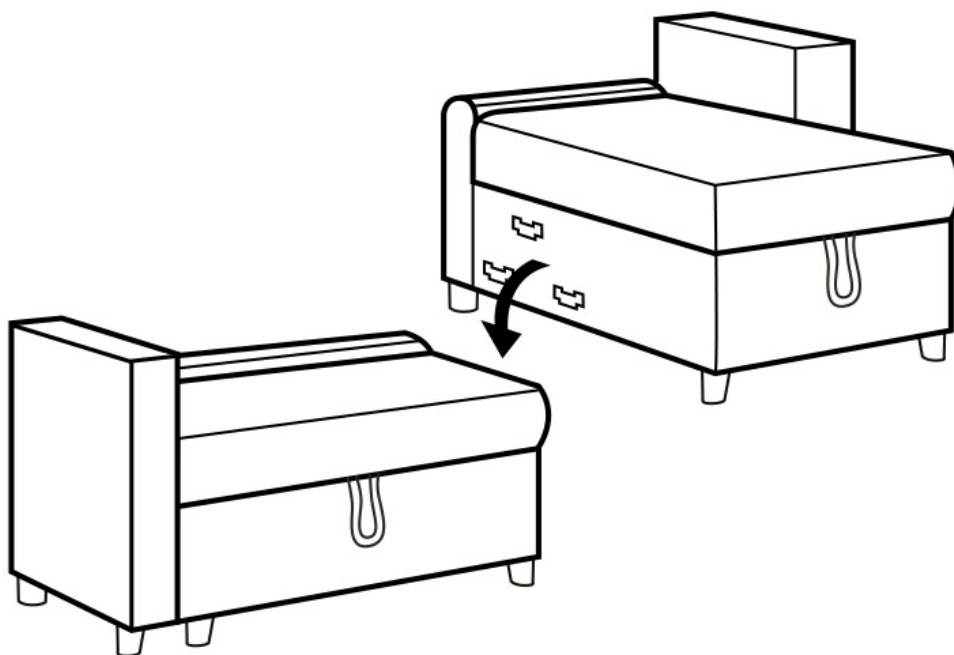

4

Deslize os dois encostos para dentro dos carris do sofá e do banco.

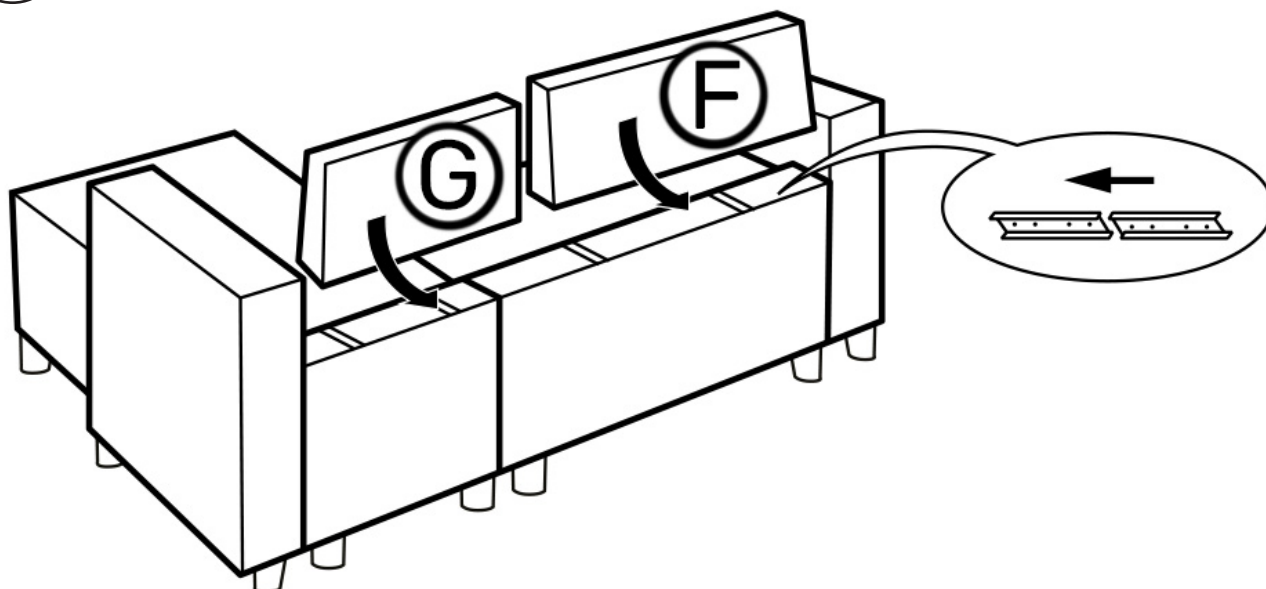

5

Para aceder à caixa de arrumação, levante o assento do sofá.

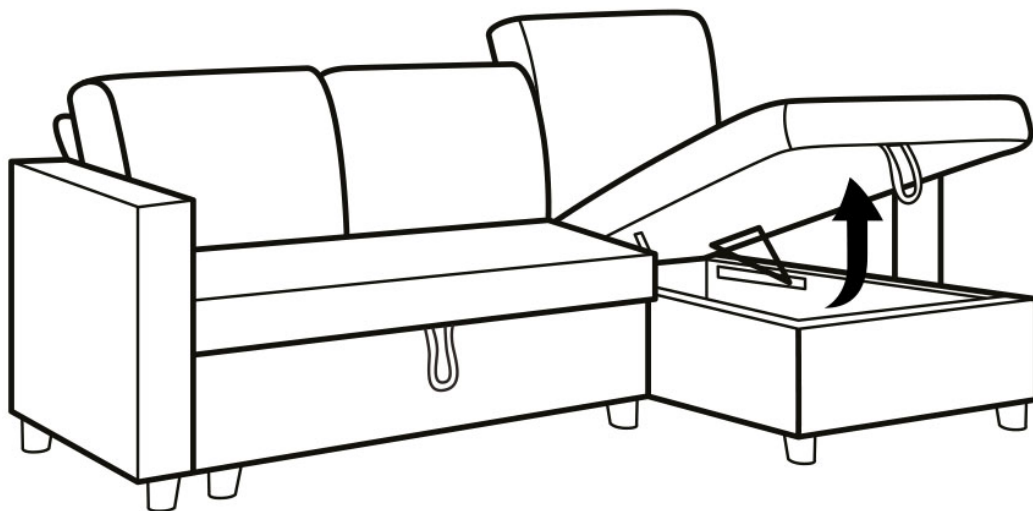

6

Para desdobrar a cama, puxe a correia e levante a cama.

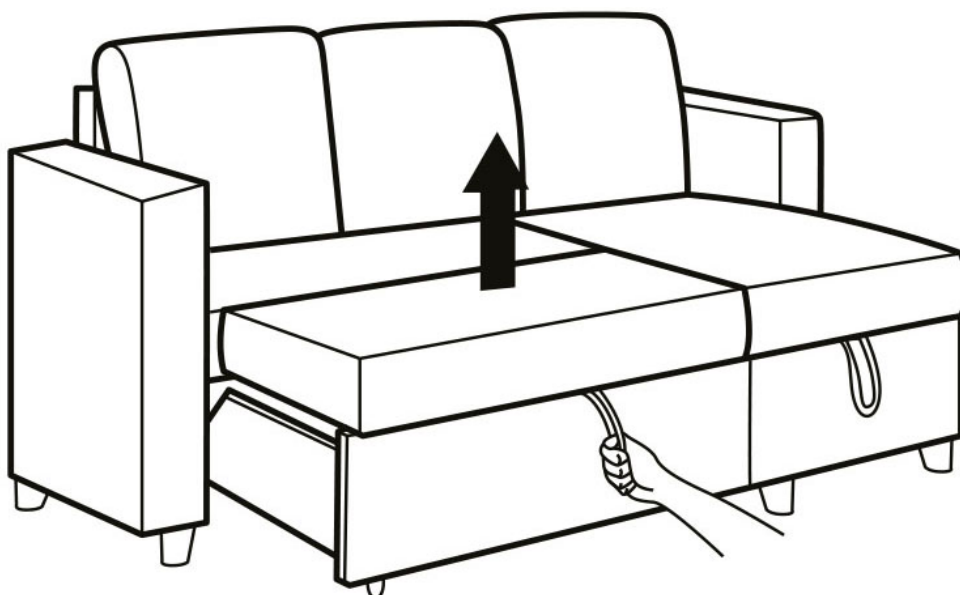

Se desejar colocar o seu sofá no lado **ESQUERDO** do sofá, consulte estas instruções (são necessárias 2 pessoas para montar o sofá):

1

Enrosque as pernas nos apoios dos braços, o sofá e a chaise-longue e as rodas na gaveta na posição indicada.

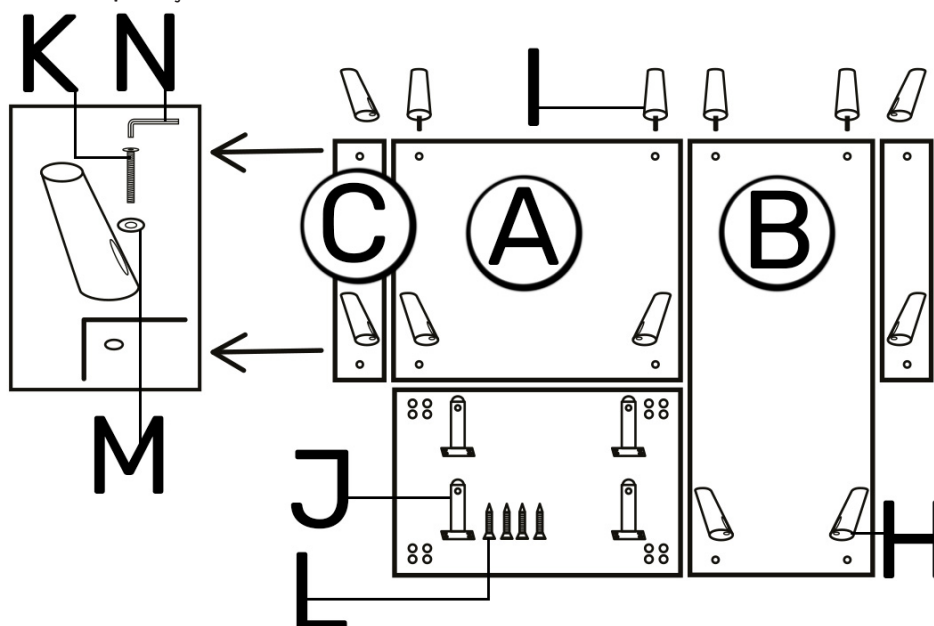

2

Fixe os apoios de braço ao sofá e à chaise-longue
 - Insira o apoio de braço esquerdo no sofá de cima para baixo,
 - Insira o apoio de braço direito no sofá, de baixo para cima.

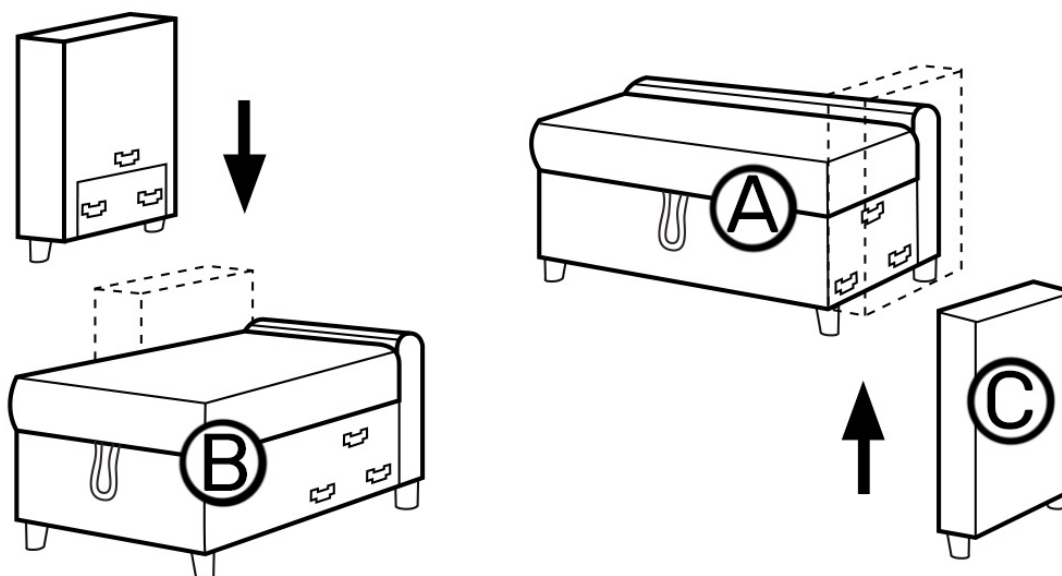

3

Prenda o sofá ao assento.

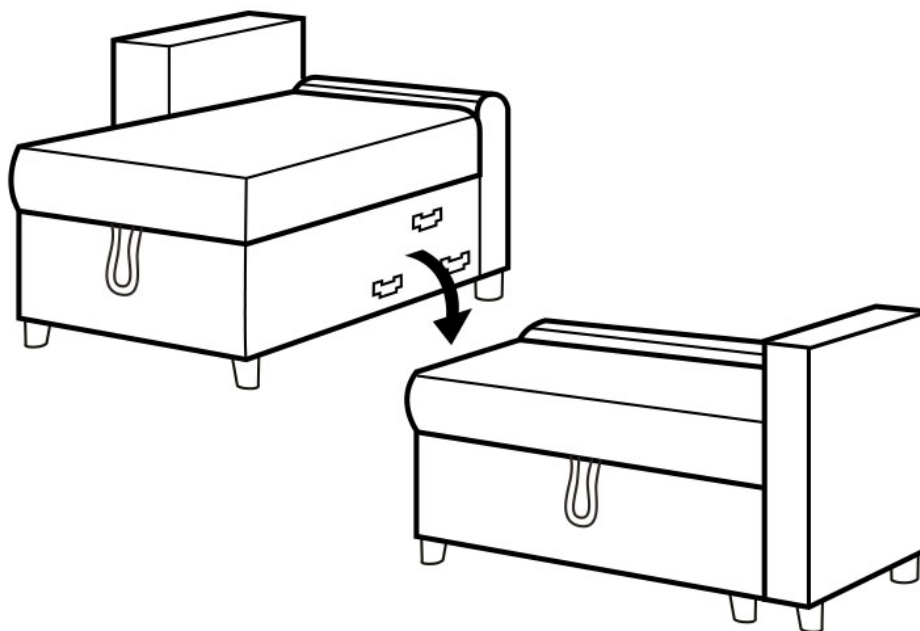

4

Deslize os dois encostos para dentro dos carris do sofá e do banco.

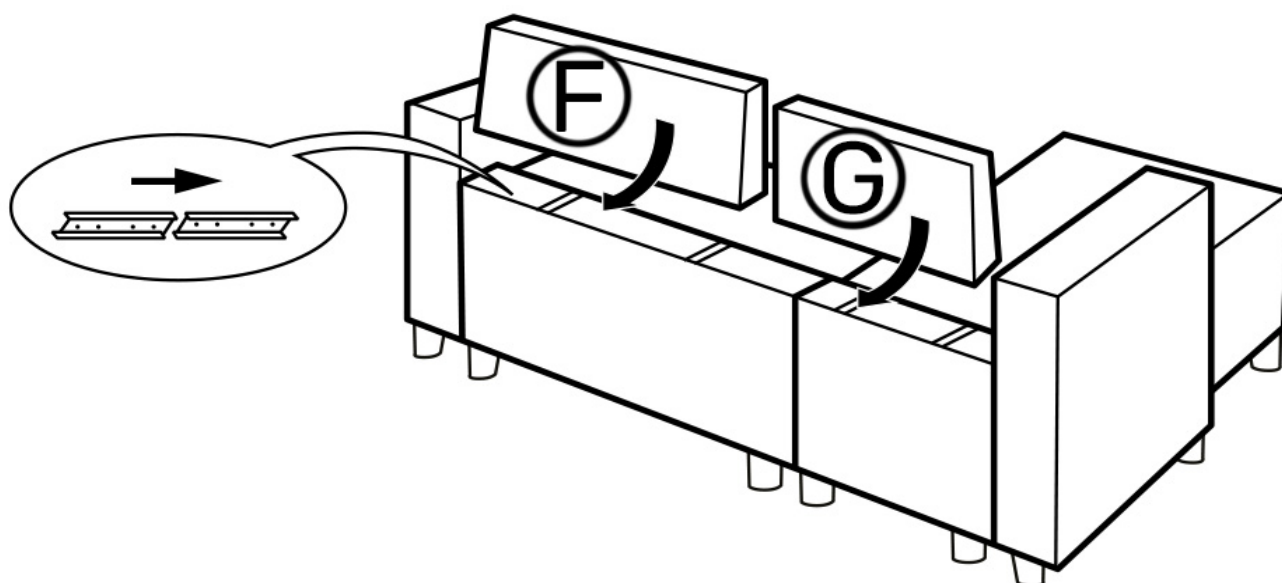

5

Para aceder à caixa de arrumação, levante o assento do sofá.

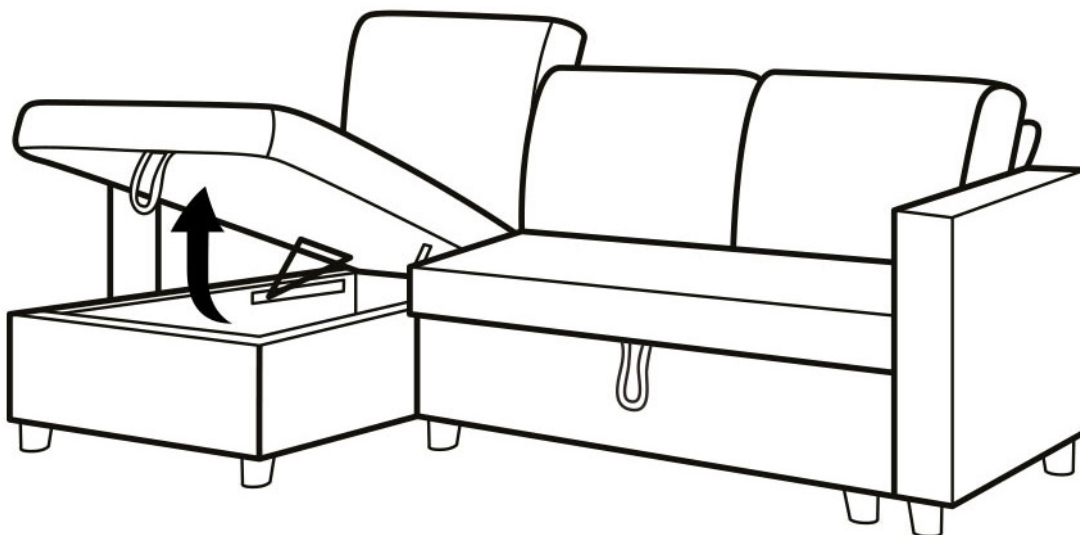

6

Para desdobrar a cama, puxe a correia e levante a cama.

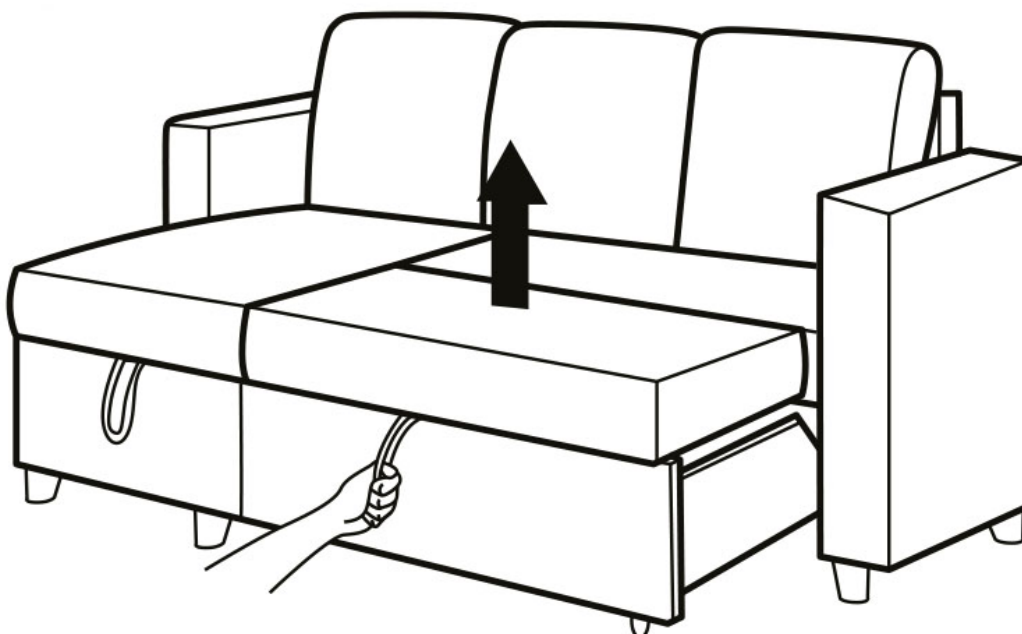

- 
- A large, stylized leaf icon in shades of grey is located in the top left corner of the page.
- FR** Veuillez conserver ce manuel pour référence ultérieure.
En cas de problème avec votre produit, nous vous invitons à contacter notre service client par mail à contact@happygarden.fr ou par téléphone au +33.3.20.267.567
- ES** Le rogamos conserve este manual de instrucciones para futuras consultas Si encuentra algún problema con su producto, le solicitamos que contacte con nuestro servicio de atención al cliente por correo electrónico: spv@happy-garden.es o por teléfono al 919 035 926
- EN** Please keep this manual for future reference.
If you have any problems with your product, please contact our customer service department by email at contact@happygarden.fr or by phone at +33.3.20.267.567
- DE** Bitte bewahren Sie diese Anleitung zum späteren Nachschlagen auf.
Falls Sie ein Problem mit Ihrem Produkt haben, wenden Sie sich bitte an unseren Kundenservice per E-Mail an contact@happygarden.fr oder telefonisch unter 0800.181.5780
- NL** Bewaar deze handleiding voor toekomstig gebruik.
Indien u problemen heeft met uw product, neem dan contact op met onze klantendienst via e-mail op contact@happygarden.fr of per telefoon op +31.85.208.4162
- IT** Si prega di conservare questo manuale per riferimento futuro.
In caso di problemi con il prodotto, si prega di contattare il nostro servizio clienti via e-mail a contact@happygarden.fr o per telefono al +33.3.20.267.567
- PT** Por favor, guarde este manual para referência futura.
Se tiver algum problema com o seu produto, contacte por favor o nosso departamento de serviço ao cliente através do e-mail contact@happygarden.fr ou por telefone para +33.3.20.267.567



happy garden

ALLSTORE SAS
121 allée Hélène Boucher
PA du Moulin
59118 WAMBRECHIES
FRANCE