

IZALCO
BQ572

happy garden

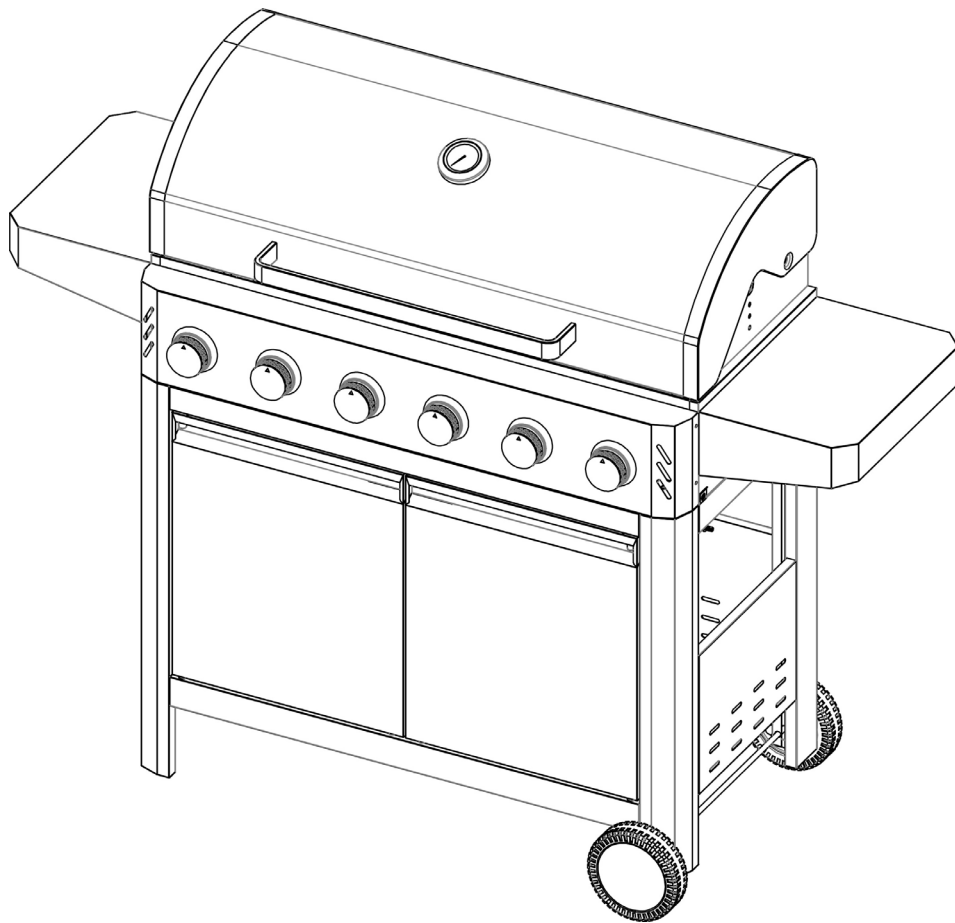

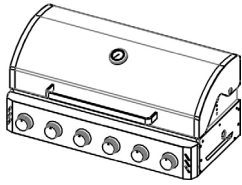

A x1

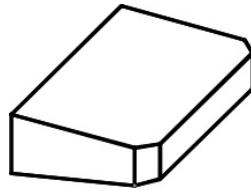

B x2

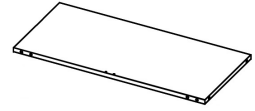

C x1

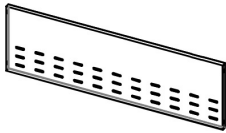

D x1



E x2

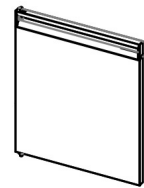

F x1

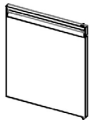

G x1



H x3

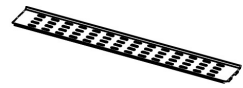

I x1



J x6



K x1



L x1



M x1

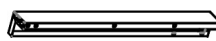

N x1



O x1



P_{x1}



S_{x2}

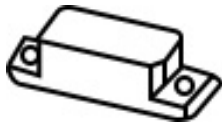

V_{x1}

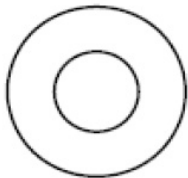

Y_{x2}



Q_{x1}

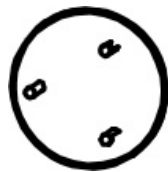

T_{x2}

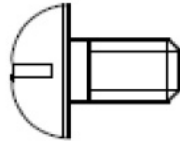

W_{x54}
M6x10



Z_{x2}



R_{x1}



U_{x1}



X_{x2}
M4x8

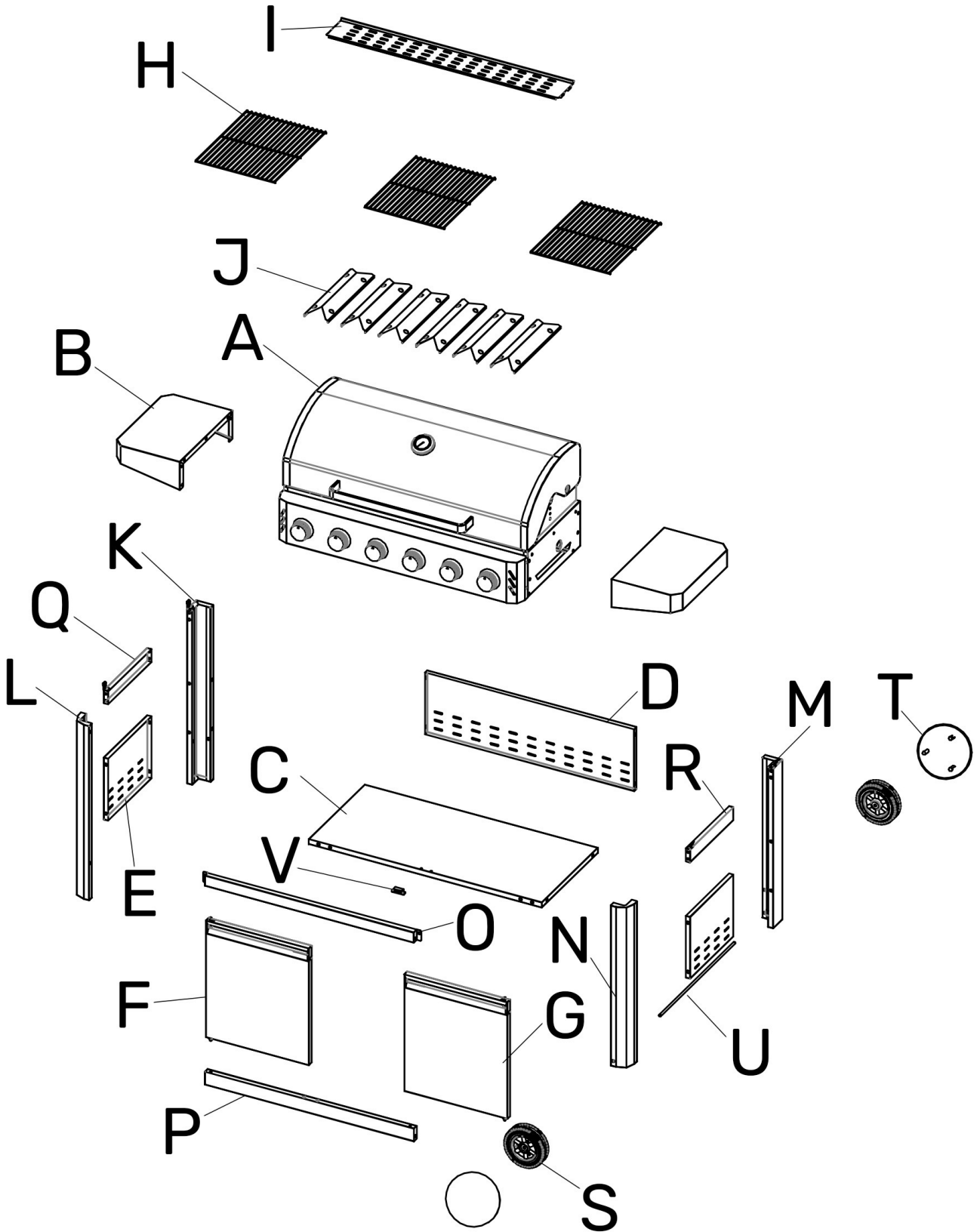

1

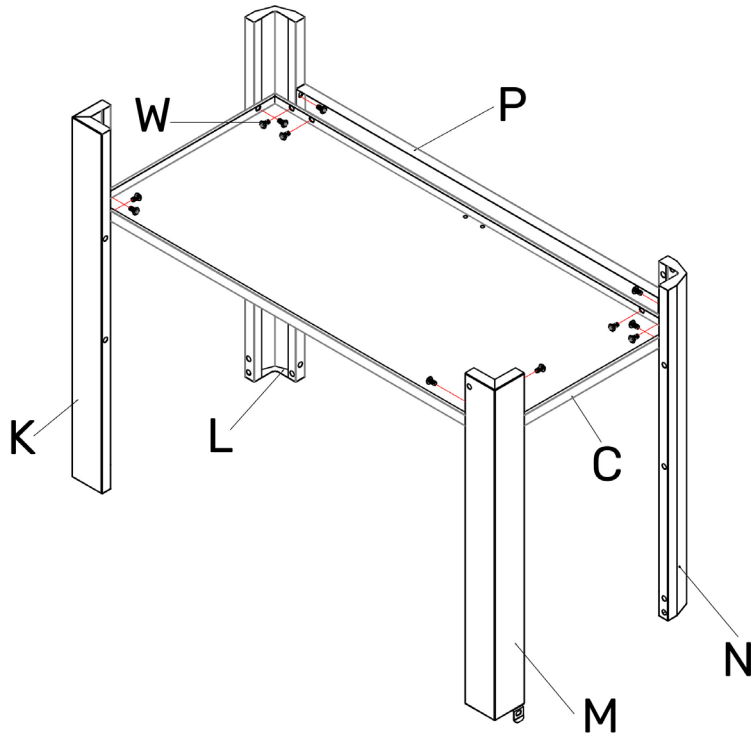

2

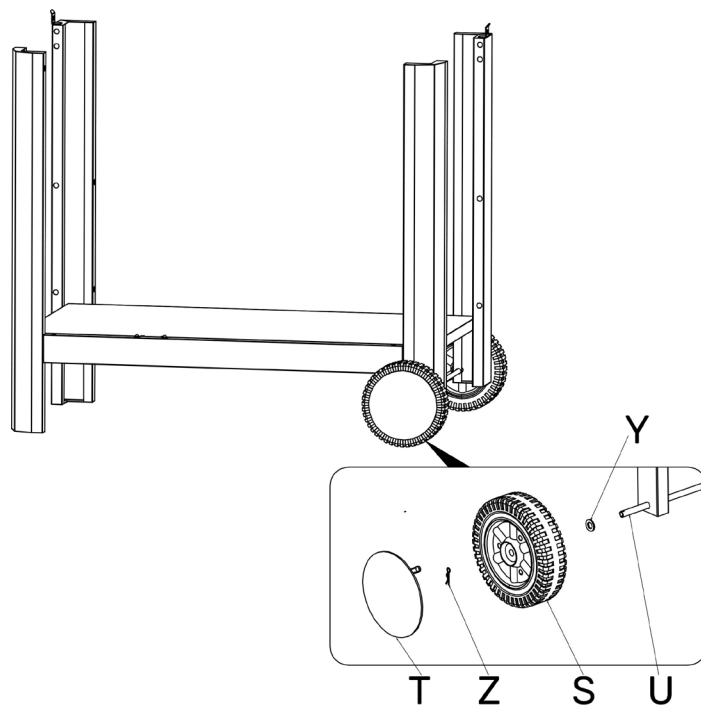

3

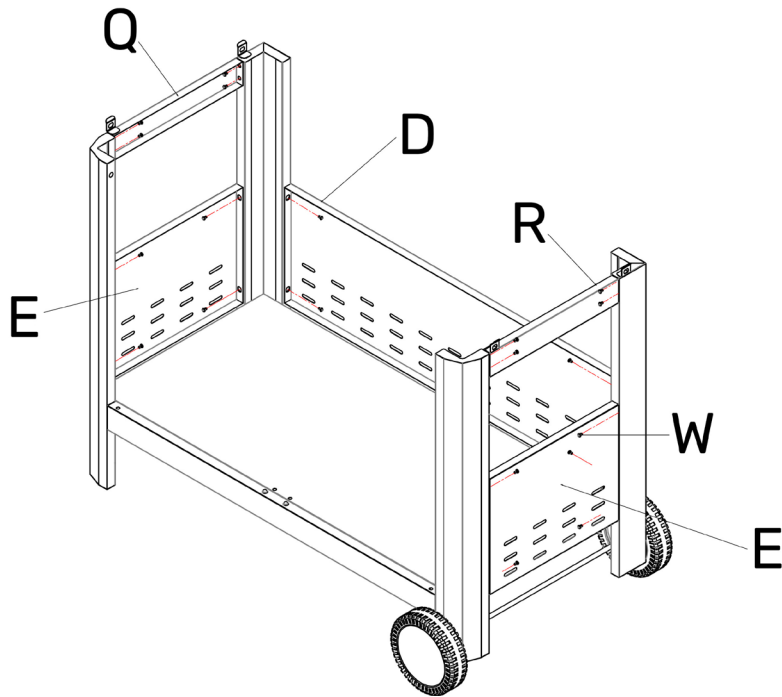

4

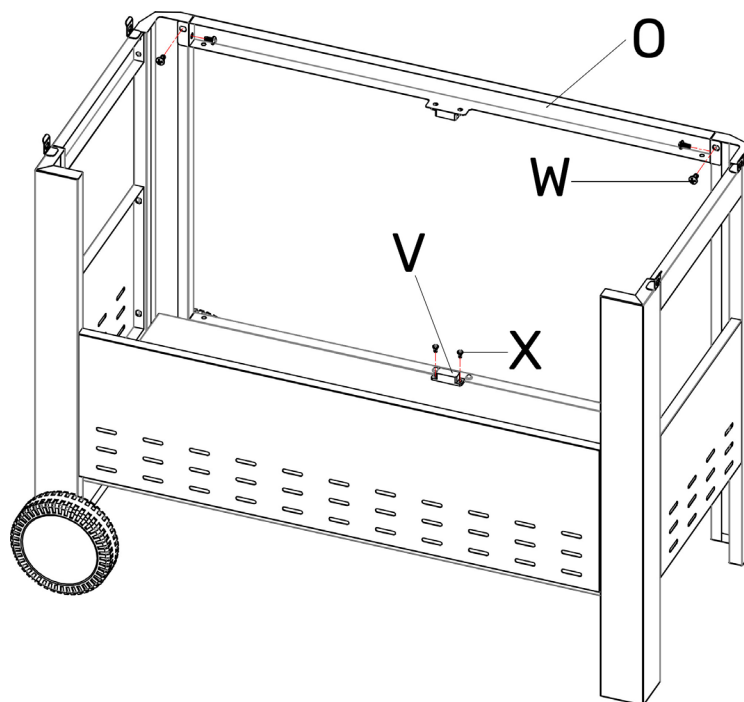

5

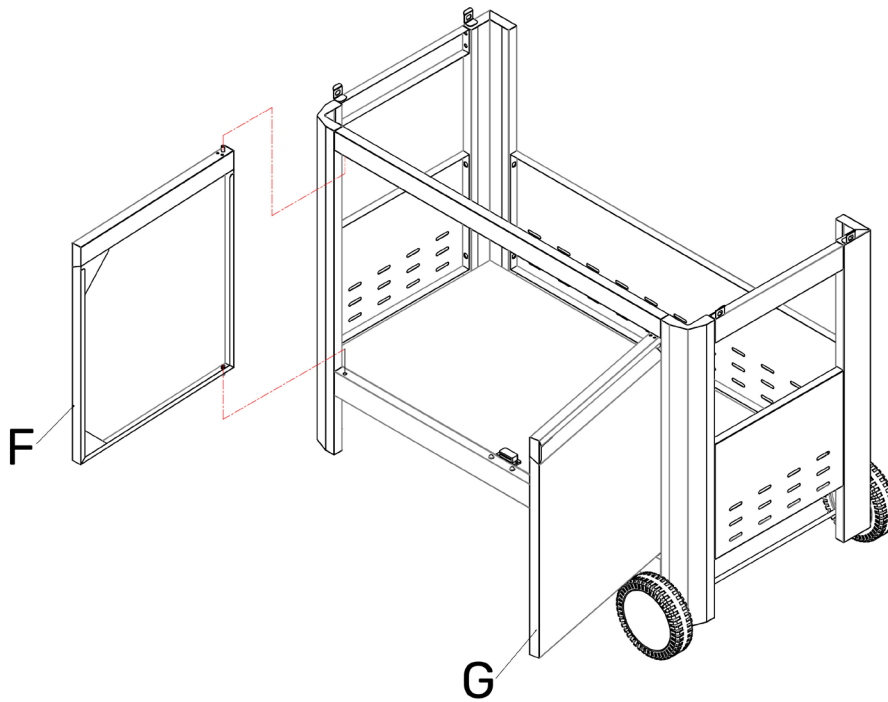

6

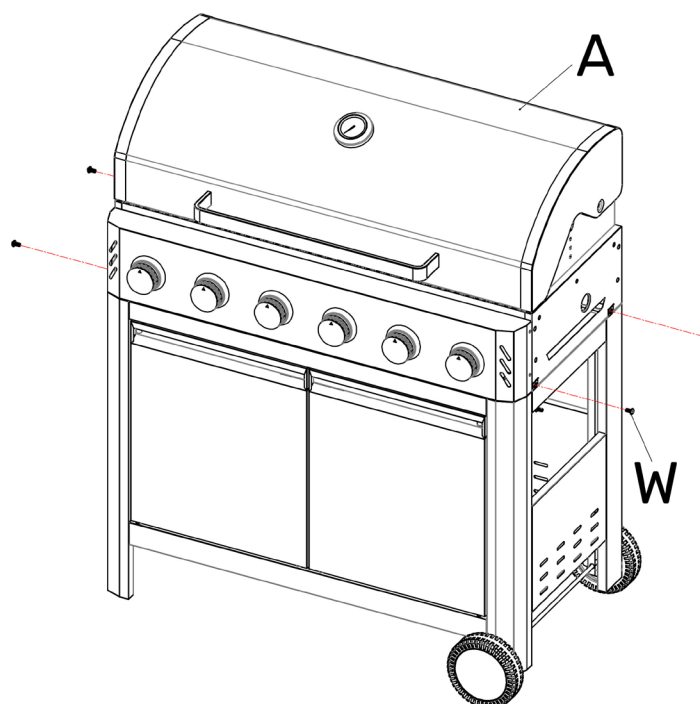

7

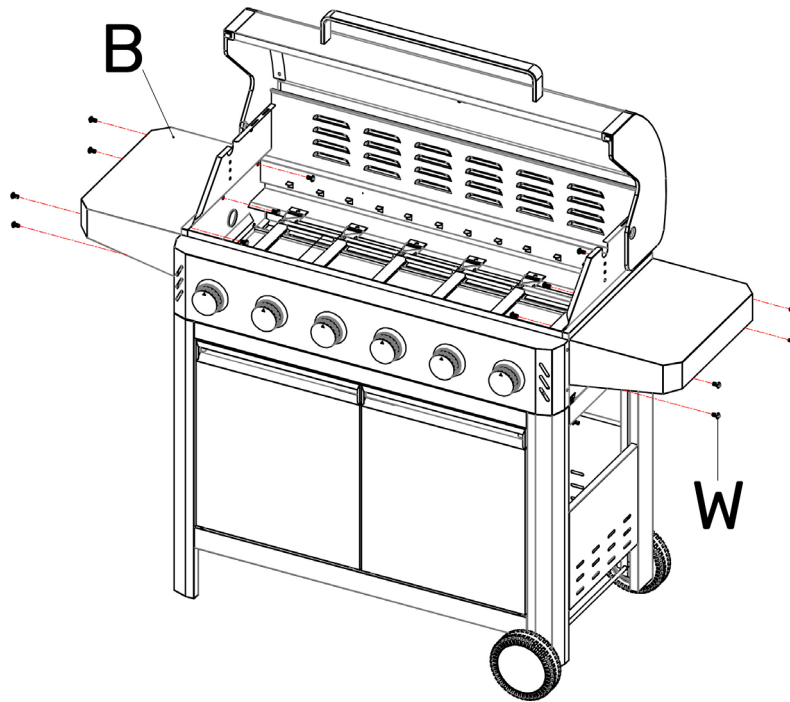

8

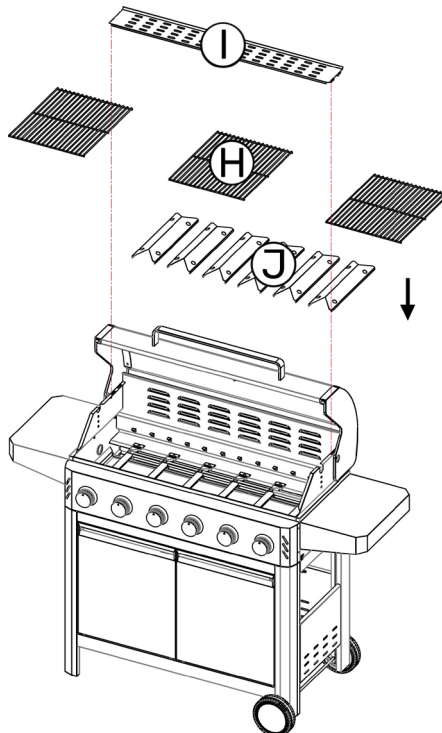

9

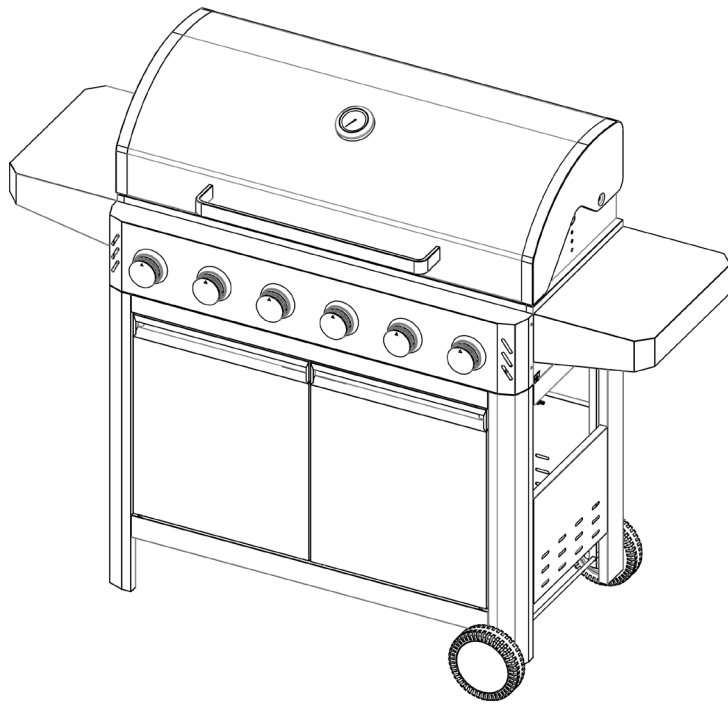

- 
- A large, stylized grey leaf icon is located in the top left corner of the page, partially overlapping the text area.
- FR** Veuillez conserver ce manuel pour référence ultérieure.
En cas de problème avec votre produit, nous vous invitons à contacter notre service client par mail à contact@happygarden.fr ou par téléphone au +33.3.20.267.567
- ES** Le rogamos conserve este manual de instrucciones para futuras consultas Si encuentra algún problema con su producto, le solicitamos que contacte con nuestro servicio de atención al cliente por correo electrónico: spv@happy-garden.es o por teléfono al 919 035 926
- EN** Please keep this manual for future reference.
If you have any problems with your product, please contact our customer service department by email at contact@happygarden.fr or by phone at +33.3.20.267.567
- DE** Bitte bewahren Sie diese Anleitung zum späteren Nachschlagen auf.
Falls Sie ein Problem mit Ihrem Produkt haben, wenden Sie sich bitte an unseren Kundenservice per E-Mail an contact@happygarden.fr oder telefonisch unter 0800.181.5780
- NL** Bewaar deze handleiding voor toekomstig gebruik.
Indien u problemen heeft met uw product, neem dan contact op met onze klantendienst via e-mail op contact@happygarden.fr of per telefoon op +31.85.208.4162
- IT** Si prega di conservare questo manuale per riferimento futuro.
In caso di problemi con il prodotto, si prega di contattare il nostro servizio clienti via e-mail a contact@happygarden.fr o per telefono al +33.3.20.267.567
- PT** Por favor, guarde este manual para referência futura.
Se tiver algum problema com o seu produto, contacte por favor o nosso departamento de serviço ao cliente através do e-mail contact@happygarden.fr ou por telefone para +33.3.20.267.567



happy garden

ALLSTORE SAS
121 allée Hélène Boucher
PA du Moulin
59118 WAMBRECHIES
FRANCE