

# Moon

Class 1  
 E27

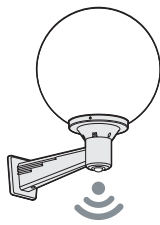

x1



x1

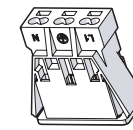

x1



x3



x4



x3

## 1 Fixation murale Fix to the wall

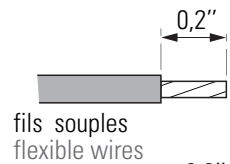
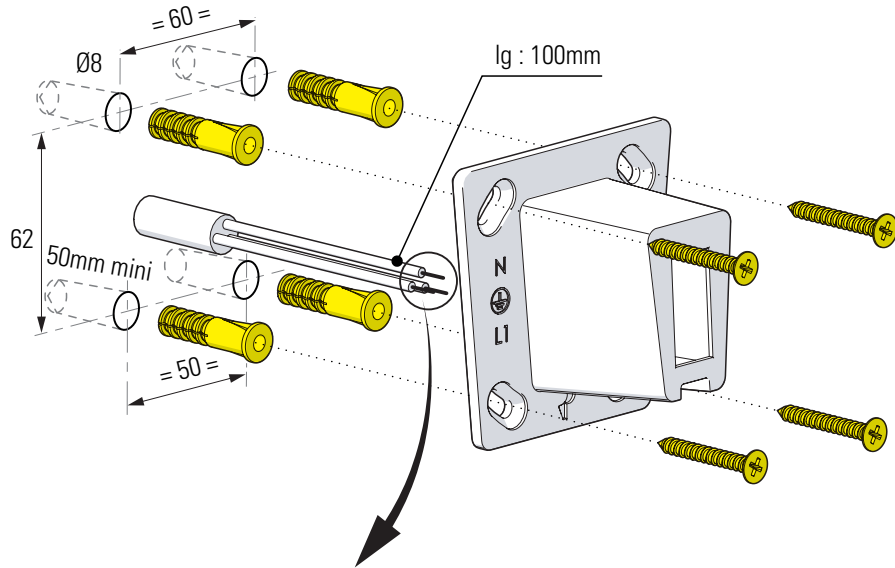

fils souples  
 flexible wires

Sertir les embouts sur les fils  
 Crimp the wire ferrules

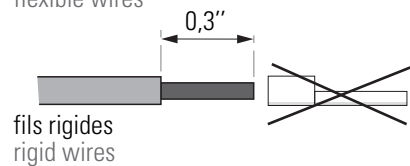

fils rigides  
 rigid wires

Pas d'embout  
 No wire ferrule

## 2 Raccordement électrique Connect electrical wires

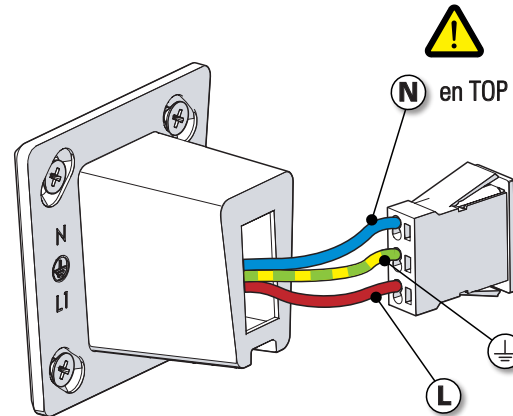

## 3 Montage du connecteur Put in place connector

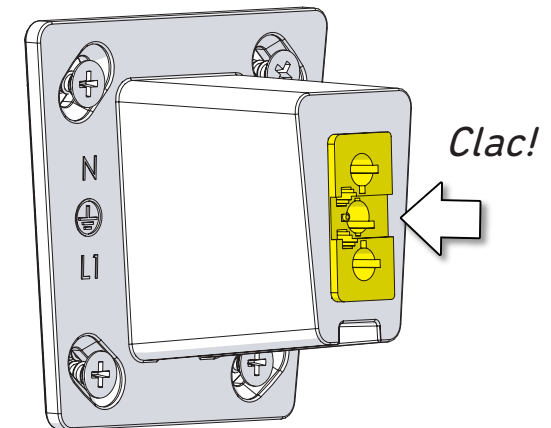

**4** Montage de la lampe & du globe  
Install the light-bulb & globe

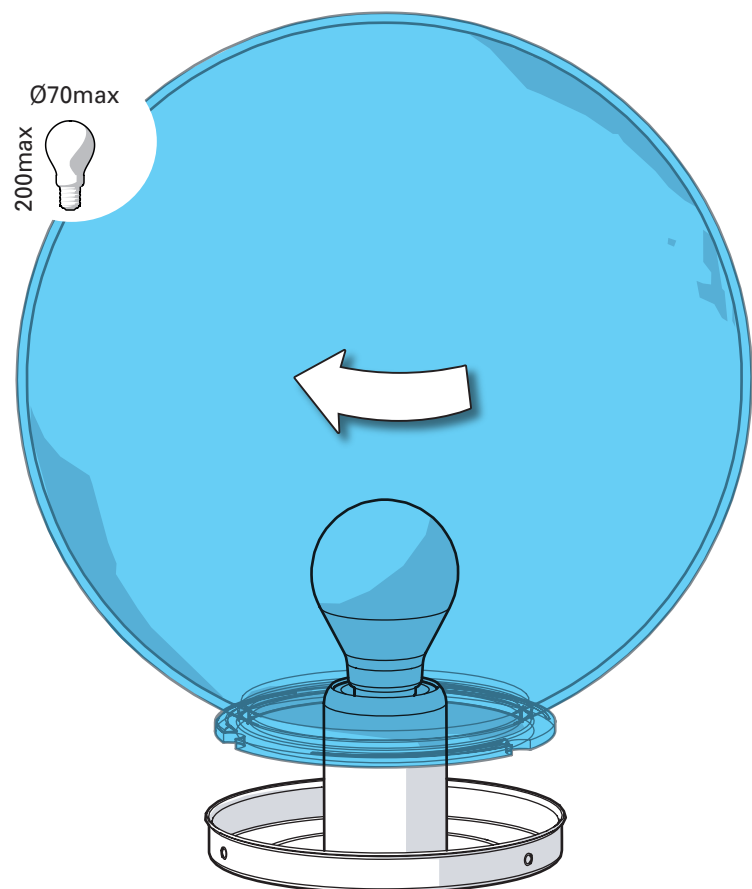

**5** Montage du luminaire & serrage de la vis de blocage  
Assemble the luminaire & tighten the locking screw

